

Priming evercare® inLine

Priming recommendation to prime evercare® inLine Transfusion set

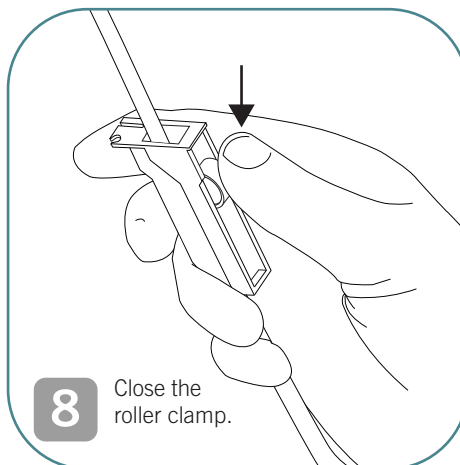
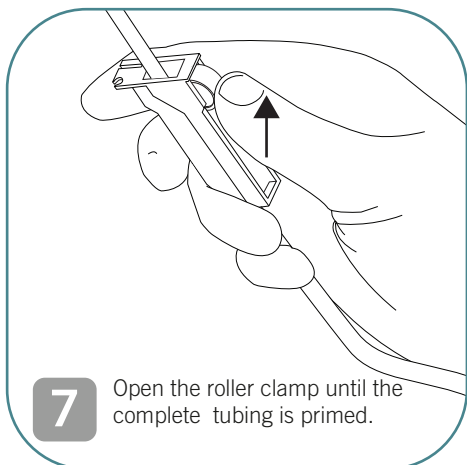
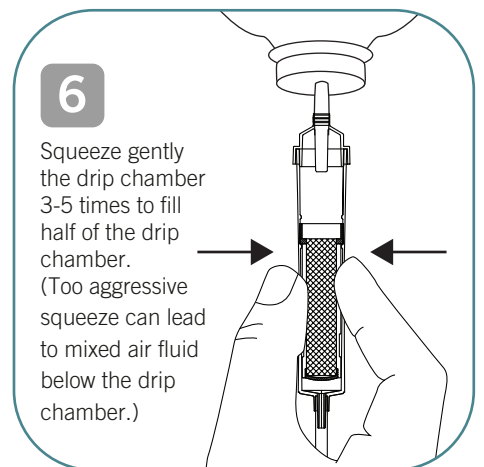
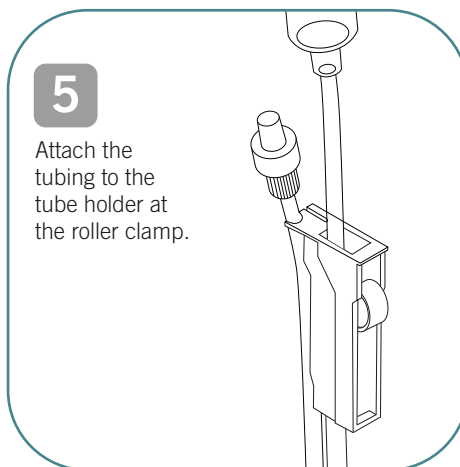
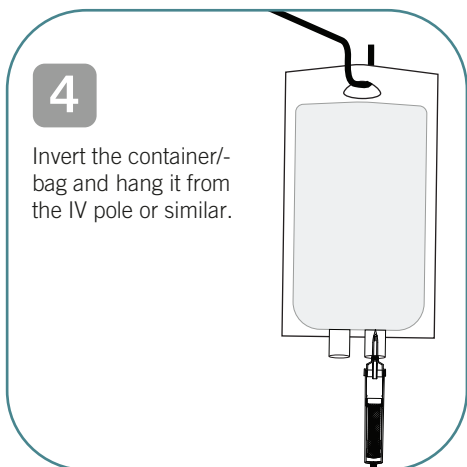
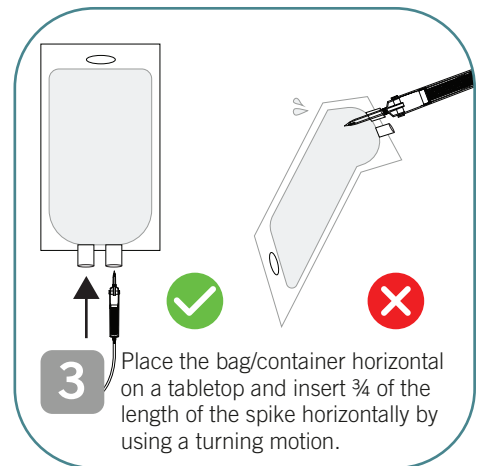
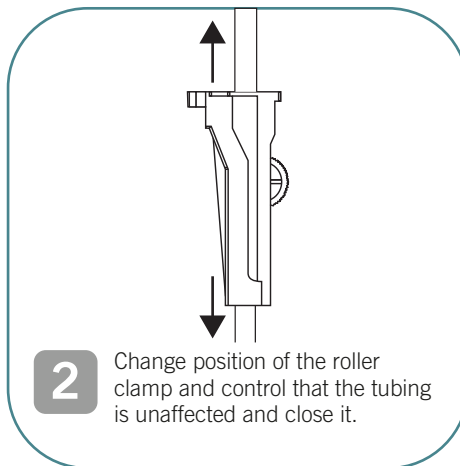
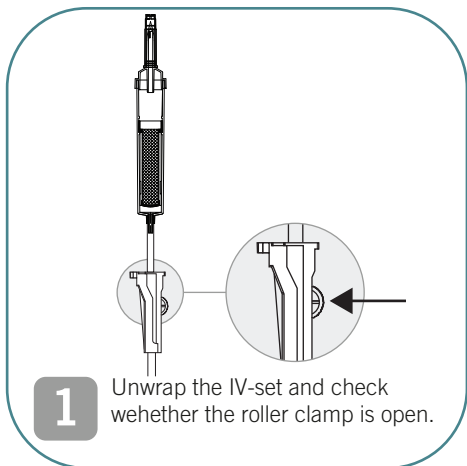

! See the package for complete IFU instructions for use, this is only a guide for users !

DO NOT OVER-TIGHTEN connections. **DO NOT USE** any instruments to tighten connections

Contact person:

REF
10682
10672
10673
10675
10684
10680