

# Surgical drapes and sets



October 25, 2024

evercare<sup>®</sup>  
medical | Part of  
Asker  
Healthcare  
Group

# We provide medical supplies to the healthcare sector that make a difference

Evercare Medical develops products that make a positive difference in the European healthcare sector, providing a comprehensive offering within medical supplies to health care providers and patients. We aim to offer a best-in-class portfolio in terms of quality and sustainability, including the new brand Embra® with products that have a lighter environmental footprint, evercare®, and SELEFA®. With over 2,800 products in 33 different product groups, our mission is to support the healthcare sector to improve patient outcomes and reduce total cost of care, while working with our suppliers to ensure sustainable practices throughout the value chain. Our suppliers and manufacturers are carefully selected to ensure they share our view and meet our high requirements in terms of quality, the environment and social responsibility. All products undergo a comprehensive quality control process with extensive quality reviews, including regular inspections of production facilities and randomized audits. Evercare Medical operates two business units, Surgery, Wound & Hospital Care and Gloves & Protection, currently serving 14 countries across Europe. We are headquartered in Stockholm, Sweden and count 35 employees. Evercare Medical is a part of Asker Healthcare Group.

Evercare Medical – we care more.

**Embra**   
Caring for the future

Embra®, derived from the word “embrace” stands for a clear commitment to embrace both environmental and social sustainability. Embra® works consistently and continuously to give the world healthcare solutions that focus on lowering environmental impact, while delivering quality and performance for patients and caregivers.

Our mission is to develop responsible healthcare solutions focused on lowering the environmental impact while heightening quality for patients and caregivers. We always consider utilizing innovative processes and raw materials that enable us to reach our goals. We also hold each and every Embra® product to strong ethical codes, and to quality reviews throughout its entire value chain.

This is the Embra® way. It's our way of caring for patients, caregivers and the future.

 **evercare**  
Solutions for premium care

The evercare® brand is composed of a premium product range that delivers a comprehensive assortment of examination gloves, surgical gowns and drapes, and wound care, infusion and injection solutions. Offering premium value, more features, and high quality across the product portfolio, evercare® is driven by continuous development and innovation to treat patients with the best possible clinical solutions.

 **SELEFA**  
Affordable solutions for care

The SELEFA® brand provides value for money through its wide range of affordable products, including examination gloves, paper and plastic consumables, non-woven products, bandages and gauze.



**Embra** 

 **evercare**

 **SELEFA**

## Stay updated



Access our **web page** to find your nearest distributor.



**News & Blogs** articles with knowledge sharing.



Find informational videos on **YouTube!**

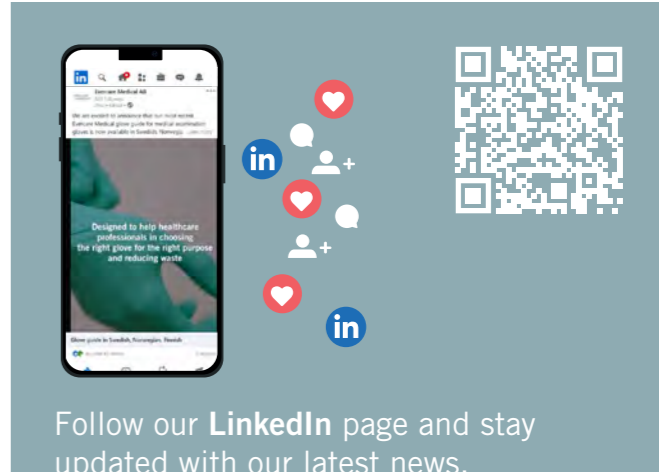

Follow our **LinkedIn** page and stay updated with our latest news.

Development under the brands Embra®, evercare® and SELEFA® follows a quality management system with established working methods and processes according to the Medical Device Regulation (MDR).

We are powered by a commitment to meeting customer needs, undertaking extensive quality control, and investing in efforts to reduce our impact on the environment, all in the name of improved patient outcomes.

# Content

## Surgical drapes and sets

	evercare® Adhesive Aperture drapes .....6		evercare® Orthopaedic drapes & sets .....72
	evercare® Adhesive drapes.....22		Hip set .....73
	evercare® Angiography drapes .....40		Vertical drape.....76
	evercare® ENT/dental drapes .....46		Extremity set.....80
	evercare® Gynae and Uro drapes & sets .....50		Hand/foot set .....84
	Gynae/cyst set.....51		Knee arthroscopy set .....88
	Gynaecology set .....52		Shoulder split set .....91
	Delivery set.....55		
	C-section set.....56		
	TUR set.....57		
	Epidural drape .....59		
	evercare® Laparoscopy drapes & sets .....60		evercare® Table covers and components .....106
	evercare® OP tape .....64		Leggings.....107
	evercare® Ophthalmic drapes & sets .....68		Genital cover.....108
			Stockinette .....109
			Arm cover .....111
			Tube holder.....112
			Mayo cover .....113
			Seat cover .....115
			Tube cover .....116
			Banded bag .....119
			Fluid collection pouch .....120
			Suction and diathermy pouch .....123
			evercare® Universal drapes & sets .....124
			evercare® Head/neck drape .....138

# evercare<sup>®</sup> Adhesive Aperture drapes

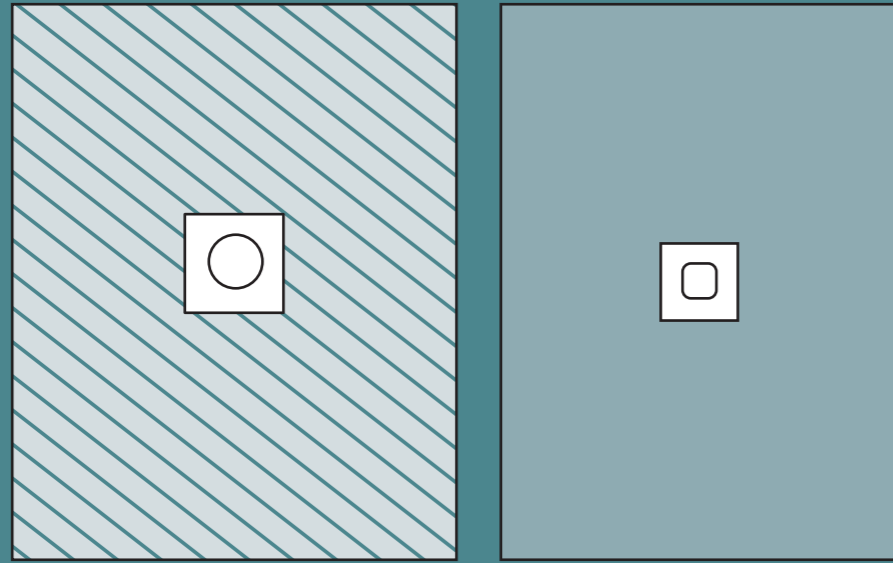

evercare<sup>®</sup> Adhesive aperture drape 50 x 60 cm, aperture 6 x 8 cm

REF: 1505-01

evercare<sup>®</sup> Adhesive aperture drape, sterile with adhesive aperture provides easy and quick draping for a variety of procedures.

## Key Features

- ▶ Easy and quick draping
- ▶ Complies to EN 13795-1 High performance critical product area requirements

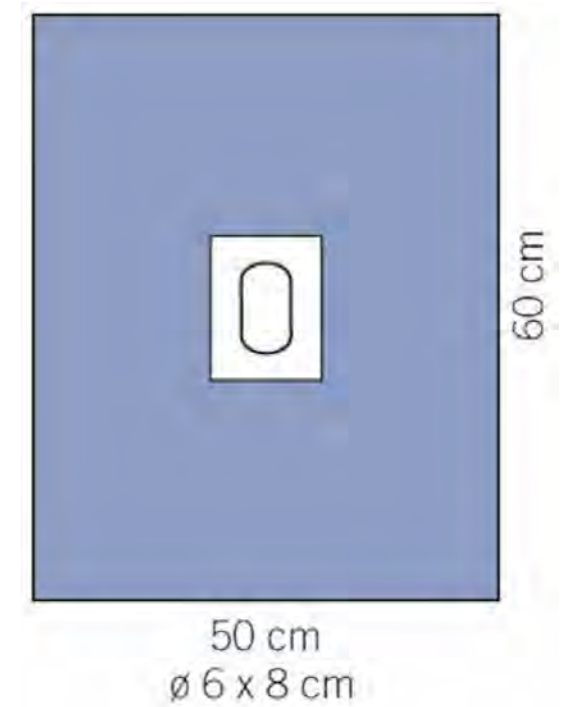

REF	DESCRIPTION	SIZE	Pack Count dispenser/carton
1505-01	Adhesive aperture drape, sterile, Blue	50 x 60 cm, Ø 6 x 8 cm	45 / 180

Sales Unit: Transport Carton

## evercare<sup>®</sup> Adhesive aperture drape, variable, 50 x 75 cm

REF: 1512-01

evercare<sup>®</sup> Adhesive aperture drapes, variable, sterile with integrated edge fixation provides easy and quick draping for a variety of procedures.

### Key Features

- ▶ Easy and quick draping
- ▶ Complies to EN 13795-1 High performance critical product area requirements

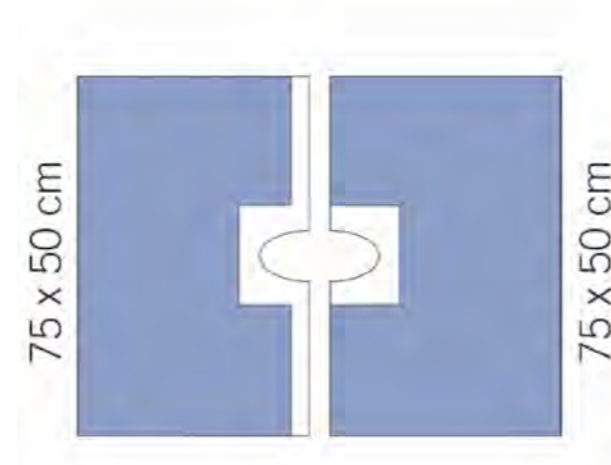

REF	DESCRIPTION	SIZE	Pack Count dispenser/carton
1512-01	Adhesive aperture drapes, variable, sterile, Blue	50 x 75 cm, adhesive edge 5 cm	35 / 140

Sales Unit: Transport Carton

## evercare<sup>®</sup> Adhesive aperture drape, variable, 75 x 100 cm

REF: 1513-01

evercare<sup>®</sup> Adhesive aperture drapes, variable, sterile with integrated edge fixation provides easy and quick draping for a variety of procedures.

### Key Features

- ▶ Easy and quick draping
- ▶ Complies to EN 13795-1 High performance critical product area requirements

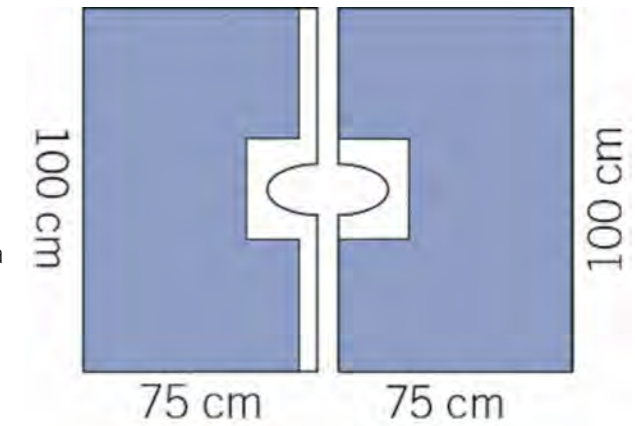

REF	DESCRIPTION	SIZE	Pack Count dispenser/carton
1513-01	Adhesive aperture drapes, variable, sterile, Blue	75 x 100 cm, adhesive edge 5 cm	20 / 80

Sales Unit: Transport Carton

evercare<sup>®</sup> Adhesive aperture drape 75 x 90 cm, aperture 6 x 8 cm

REF: 1515-01

evercare<sup>®</sup> Adhesive aperture drape, sterile with adhesive aperture provides easy and quick draping for a variety of procedures.

### Key Features

- ▶ Easy and quick draping
- ▶ Complies to EN 13795-1 High performance critical product area requirements



75 x 90 cm  
ø 6 x 8 cm

REF	DESCRIPTION	SIZE	Pack Count dispenser/carton
1515-01	Adhesive aperture drape, sterile, Blue	75 x 90 cm, ø 6 x 8 cm	25 / 100

Sales Unit: Transport Carton

evercare<sup>®</sup> Adhesive aperture drape, 100 x 125 cm, aperture 11 cm

REF: 1517

evercare<sup>®</sup> Adhesive aperture drape, sterile with adhesive aperture provides easy and quick draping for a variety of procedures.

### Key Features

- ▶ Easy and quick draping
- ▶ Complies to EN 13795-1 High performance critical product area requirements

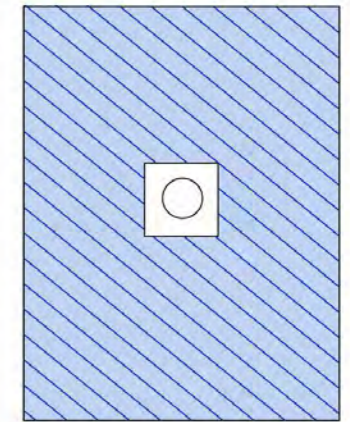

100 x 125 cm  
ø 11 cm

REF	DESCRIPTION	SIZE	Pack Count dispenser/carton
1517	Adhesive aperture drape, sterile, Blue	100 x 125 cm, ø 11 cm	20 / 80

Sales Unit: Transport Carton

evercare<sup>®</sup> Adhesive aperture drape 120 x 150 cm, aperture 5 x 7 cm

REF: 1520-01

evercare<sup>®</sup> Adhesive aperture drapes, variable, sterile with integrated edge fixation provides easy and quick draping for a variety of procedures.

### Key Features

- ▶ Easy and quick draping
- ▶ Complies to EN 13795-1 High performance critical product area requirements

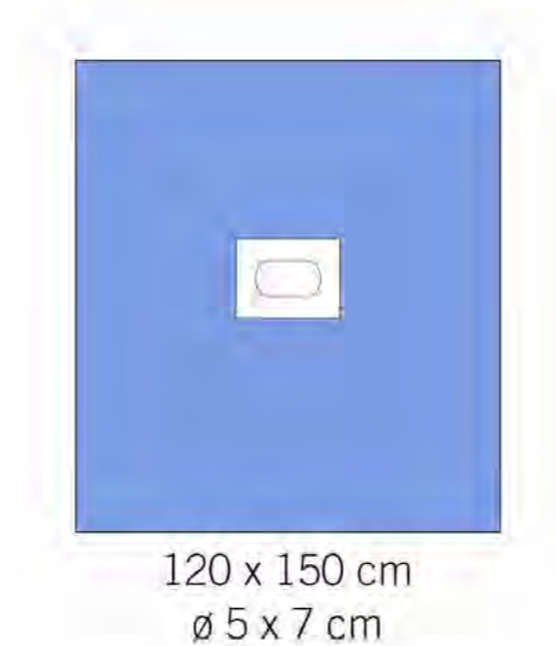

REF	DESCRIPTION	SIZE	Pack Count dispenser/carton
1520-01	Adhesive aperture drape, sterile, Blue	120 x 150 cm, ø 5 x 7 cm	20 / 80

Sales Unit: Transport Carton

evercare<sup>®</sup> Adhesive aperture drape 150 x 180 cm, aperture 5 x 7 cm

REF: 1525-01

evercare<sup>®</sup> Adhesive aperture drapes, variable, sterile with integrated edge fixation provides easy and quick draping for a variety of procedures.

### Key Features

- ▶ Easy and quick draping
- ▶ Complies to EN 13795-1 High performance critical product area requirements



REF	DESCRIPTION	SIZE	Pack Count dispenser/carton
1525-01	Adhesive aperture drape, sterile, Blue	150 x 180 cm, ø 5 x 7 cm	14 / 56

Sales Unit: Transport Carton

evercare<sup>®</sup> Adhesive aperture drape 150 x 180 cm, aperture 6 x 15 cm

REF: 1530-01

evercare<sup>®</sup> Adhesive aperture drapes, variable, sterile with integrated edge fixation provides easy and quick draping for a variety of procedures.

### Key Features

- ▶ Easy and quick draping
- ▶ Complies to EN 13795-1 High performance critical product area requirements



150 x 180 cm  
ø 6 x 15 cm

REF	DESCRIPTION	SIZE	Pack Count dispenser/carton
1530-01	Adhesive aperture drape, sterile, Blue	150 x 180 cm, ø 6 x 15 cm	12 / 48

Sales Unit: Transport Carton

evercare<sup>®</sup> Adhesive aperture drape 230 x 250 cm, aperture 12 cm

REF: 1535-02

evercare<sup>®</sup> Adhesive aperture drapes, variable, sterile with integrated edge fixation provides easy and quick draping for a variety of procedures.

### Key Features

- ▶ Easy and quick draping
- ▶ Complies to EN 13795-1 High performance critical product area requirements



230 x 250 cm  
ø 12 cm

REF	DESCRIPTION	SIZE	Pack Count dispenser/carton
1535-02	Adhesive aperture drape, sterile, Blue	230 x 250 cm, ø 12 cm	7 / 28

Sales Unit: Transport Carton



evercare<sup>®</sup> Adhesive aperture drape, 200 x 280 cm, aperture 14 x 14 cm

REF: 1537-01

evercare<sup>®</sup> Adhesive aperture drapes, variable, sterile with integrated edge fixation provides easy and quick draping for a variety of procedures.

### Key Features

- ▶ Easy and quick draping
- ▶ Complies to EN 13795-1 High performance critical product area requirements



200 x 280 cm  
ø 14 x 14 cm

REF	DESCRIPTION	SIZE	Pack Count dispenser/carton
1537-01	Adhesive aperture drape, sterile, Blue	200 x 280 cm, ø 14 x 14 cm	7 / 28

Sales Unit: Transport Carton

evercare<sup>®</sup> Adhesive aperture drape, 200 x 240 cm, aperture 12 cm

REF: 1538-01

evercare<sup>®</sup> Adhesive aperture drapes, variable, sterile with integrated edge fixation provides easy and quick draping for a variety of procedures.

### Key Features

- ▶ Easy and quick draping
- ▶ Complies to EN 13795-1 High performance critical product area requirements



200 x 240 cm  
ø 12 cm

REF	DESCRIPTION	SIZE	Pack Count dispenser/carton
1538-01	Adhesive aperture drape, sterile, Blue	200 x 240 cm, ø 12 cm	9 / 36

Sales Unit: Transport Carton

evercare<sup>®</sup> Adhesive aperture drape, 200 x 280 cm, aperture 15 cm

REF: 1539-01

evercare<sup>®</sup> Adhesive aperture drapes, variable, sterile with integrated edge fixation provides easy and quick draping for a variety of procedures.

### Key Features

- ▶ Easy and quick draping
- ▶ Complies to EN 13795-1 High performance critical product area requirements



200 x 280 cm  
ø 15 cm

REF	DESCRIPTION	SIZE	Pack Count dispenser/carton
1539-01	Adhesive aperture drape, sterile, Blue	200 x 280 cm, ø 15 cm	7 / 28

Sales Unit: Transport Carton

evercare<sup>®</sup> Aperture drape 50 x 60 cm, aperture 6 x 8 cm

REF: 1555-01

evercare<sup>®</sup> Aperture drape, sterile without adhesive for easy and quick draping for a variety of procedures.

### Key Features

- ▶ Easy and quick draping
- ▶ Complies to EN 13795-1 High performance critical product area requirements



50 x 60 cm  
ø 6 x 8 cm

REF	DESCRIPTION	SIZE	Pack Count dispenser/carton
1555-01	Aperture drape, sterile, Blue	50 x 60 cm, ø 6 x 8 cm	45 / 180

Sales Unit: Transport Carton

evercare® Aperture drape 75 x 90 cm, aperture 6 x 8 cm

REF: 1565-01

evercare® Aperture drape, sterile without adhesive for easy and quick draping for a variety of procedures.

### Key Features

- ▶ Easy and quick draping
- ▶ Complies to EN 13795-1 High performance critical product area requirements



75 x 90 cm  
ø 6 x 8 cm

REF	DESCRIPTION	SIZE	Pack Count dispenser/carton
1565-01	Aperture drape, sterile, Blue	75 x 90 cm, ø 6 x 8 cm	25 / 100

Sales Unit: Transport Carton



# evercare<sup>®</sup> Adhesive drapes

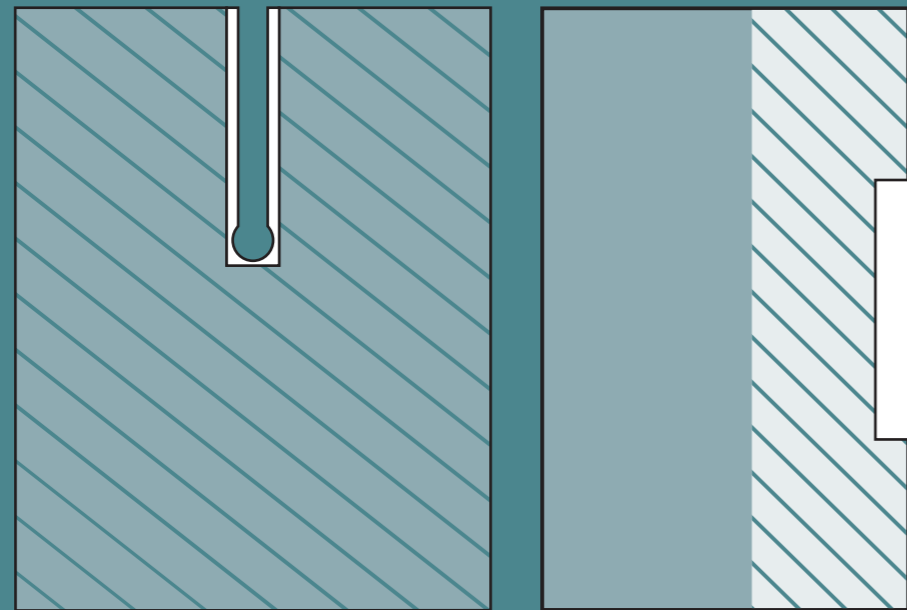

## evercare<sup>®</sup> Adhesive split sheet 150x183 cm split 7x70 cm

REF: 1308

evercare<sup>®</sup> Adhesive split sheet, sterile provides a versatile easy-to-use draping solutions for wide range of procedures in orthopaedics, ear/nose/throat, thoracic and general surgery.

### Key Features

- ▶ Easy-to-use draping
- ▶ Available in a wide range of sizes and designs
- ▶ Complies to EN 13795-1 High performance critical product area requirements



REF	DESCRIPTION	SIZE	Pack Count dispenser/carton
1308	Adhesive split sheet, sterile, Blue	150 x 183 cm, split 7 x 70 cm	9 / 36

Sales Unit: Transport Carton

evercare<sup>®</sup> Adhesive split sheet, bilateral, 230 x 290 cm, splits 6 x 90 cm

REF: 1309

evercare<sup>®</sup> Adhesive split sheet, sterile with absorbent patch provide versatile easy-to-use draping solutions for wide range of procedures in orthopaedics, ear/nose/throat, thoracic and general surgery.

### Key Features

- ▶ Absorbent patch
- ▶ Easy-to-use draping
- ▶ Available in a wide range of sizes and designs
- ▶ Complies to EN 13795-1 High performance critical product area requirements

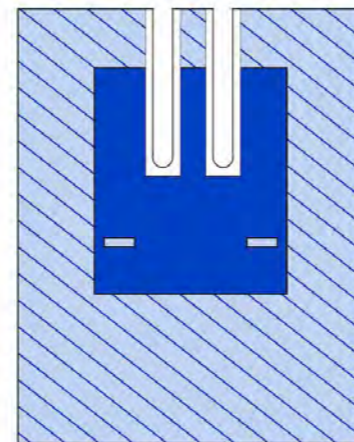

230 x 290 cm  
U = 6 x 90 cm

REF	DESCRIPTION	SIZE	Pack Count dispenser/carton
1309	Adhesive split sheet, sterile, Blue	230 x 290 cm, splits 6 x 90 cm	6 / 12

Sales Unit: Transport Carton

evercare<sup>®</sup> Adhesive split sheet 150 x 250 cm, split 7 x 70 cm

REF: 1310-02

evercare<sup>®</sup> Adhesive split sheet, sterile provides a versatile easy-to-use draping solutions for wide range of procedures in orthopaedics, ear/nose/throat, thoracic and general surgery.

### Key Features

- ▶ Easy-to-use draping
- ▶ Available in a wide range of sizes and designs
- ▶ Complies to EN 13795-1 High performance critical product area requirements

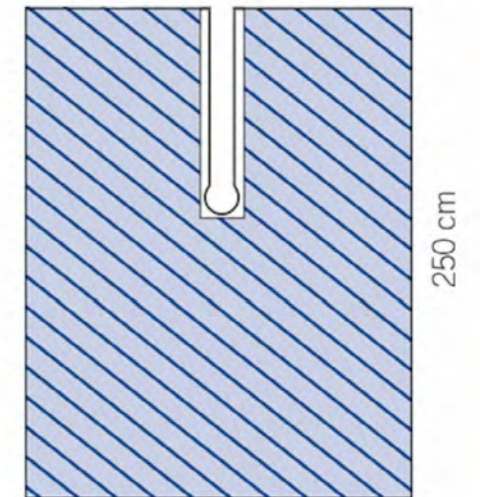

150 cm  
U = 7 x 70 cm

REF	DESCRIPTION	SIZE	Pack Count dispenser/carton
1310-02	Adhesive split sheet, sterile, Blue	150 x 250 cm, split 7 x 70 cm	8 / 32

Sales Unit: Transport Carton

## evercare<sup>®</sup> Adhesive split sheet 230 x 260 cm, split 20 x 100 cm

REF: 1315-01

evercare<sup>®</sup> Adhesive split sheet, sterile with absorbent patch provide versatile easy-to-use draping solutions for wide range of procedures in orthopaedics, ear/nose/throat, thoracic and general surgery.

### Key Features

- ▶ Absorbent patch
- ▶ Tube holders
- ▶ Easy-to-use draping
- ▶ Available in a wide range of sizes and designs
- ▶ Complies to EN 13795-1 High performance critical product area requirements

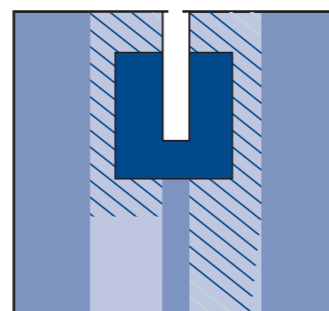

230 x 260 cm  
U = 20 x 100

REF	DESCRIPTION	SIZE	Pack Count dispenser/carton
1315-01	Adhesive split sheet, sterile, Blue	230 x 260 cm, split 20 x 100 cm	8 / 16

Sales Unit: Transport Carton

## evercare<sup>®</sup> Adhesive split sheet 230 x 260 cm, split 20 x 100 cm

REF: 1316-01

evercare<sup>®</sup> Adhesive split sheet, sterile with absorbent patch provide versatile easy-to-use draping solutions for wide range of procedures in orthopaedics, ear/nose/throat, thoracic and general surgery.

### Key Features

- ▶ Absorbent patch
- ▶ Tube holders
- ▶ Easy-to-use draping
- ▶ Available in a wide range of sizes and designs
- ▶ Complies to EN 13795-1 High performance critical product area requirements

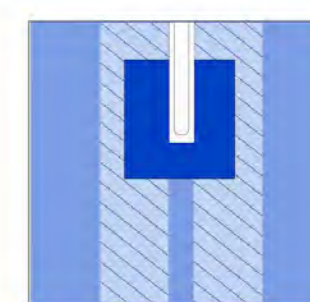

230 x 260 cm  
U = 20 x 100 cm

REF	DESCRIPTION	SIZE	Pack Count dispenser/carton
1316-01	Adhesive split sheet, sterile, Blue	230 x 260 cm, split 20 x 100 cm	8 / 16

Sales Unit: Transport Carton

## evercare<sup>®</sup> Adhesive split sheet 200 x 260 cm, split 7 x 100 cm

REF: 1318-01

evercare<sup>®</sup> Adhesive split sheet, sterile with absorbent patch provide versatile easy-to-use draping solutions for wide range of procedures in orthopaedics, ear/nose/throat, thoracic and general surgery.

### Key Features

- ▶ Absorbent patch
- ▶ Easy-to-use draping
- ▶ Available in a wide range of sizes and designs
- ▶ Complies to EN 13795-1 High performance critical product area requirements



200 x 260 cm  
U = 7 x 100 cm

REF	DESCRIPTION	SIZE	Pack Count dispenser/carton
1318-01	Adhesive split sheet, sterile, Blue	200 x 260 cm, split 7 x 100 cm	9 / 18

Sales Unit: Transport Carton

## evercare<sup>®</sup> Adhesive drape sheet, 45 x 75 cm

REF: 1451-01

evercare<sup>®</sup> Adhesive drape sheet, sterile is a versatile, impervious, absorbent drapes with an adhesive strip for secure adhesion.

### Key Features

- ▶ Impervious
- ▶ Absorbent
- ▶ Secure adhesion
- ▶ Available in several sizes
- ▶ Complies to EN 13795-1 High performance critical product area requirements

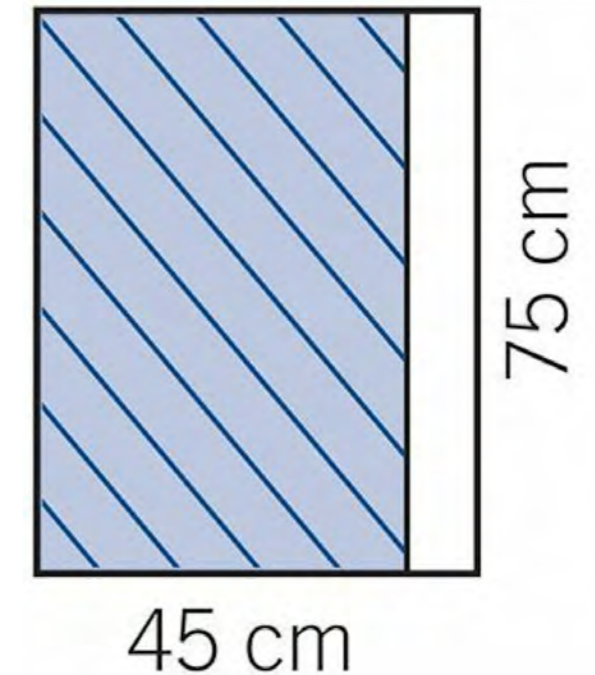

REF	DESCRIPTION	SIZE	Pack Count dispenser/carton
1451-01	Adhesive drape sheet, sterile, Blue	45 x 75 cm	30 / 120

Sales Unit: Transport Carton

## evercare<sup>®</sup> Adhesive drape sheet, 50 x 50 cm

REF: 1452-01

evercare<sup>®</sup> Adhesive drape sheet, sterile is a versatile, impervious, absorbent drapes with an adhesive strip for secure adhesion.

### Key Features

- ▶ Impervious
- ▶ Absorbent
- ▶ Secure adhesion
- ▶ Available in several sizes
- ▶ Complies to EN 13795-1 High performance critical product area requirements

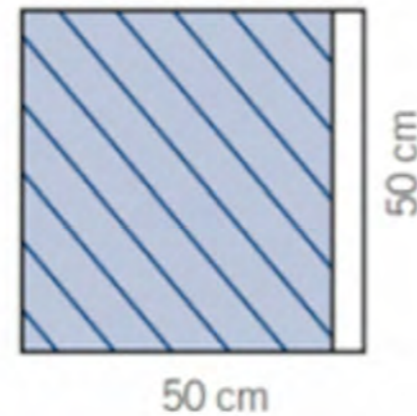

REF	DESCRIPTION	SIZE	Pack Count dispenser/carton
1452-01	Adhesive drape sheet, sterile, Blue	50 x 50 cm	30 / 120

Sales Unit: Transport Carton

## evercare<sup>®</sup> Adhesive drape sheet 100 x 100 cm

REF: 1453-01

evercare<sup>®</sup> Adhesive drape sheet, sterile is a versatile, impervious, absorbent drapes with an adhesive strip for secure adhesion.

### Key Features

- ▶ Impervious
- ▶ Absorbent
- ▶ Secure adhesion
- ▶ Available in several sizes
- ▶ Complies to EN 13795-1 High performance critical product area requirements

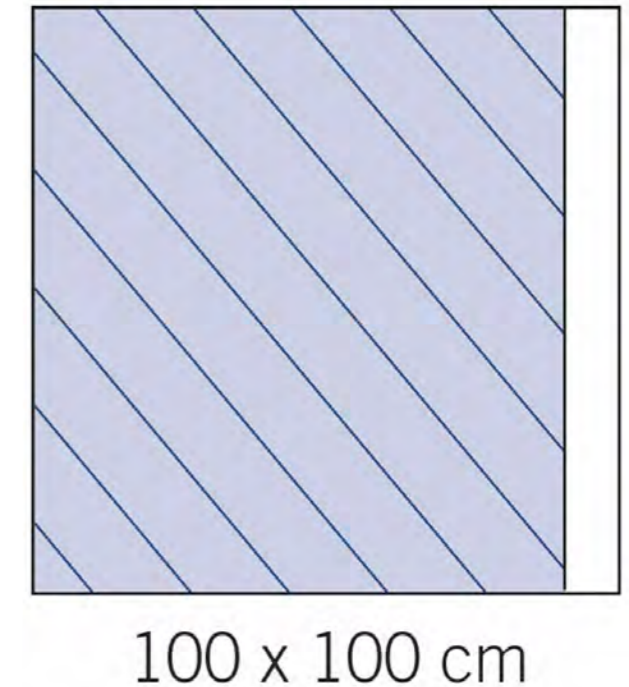

REF	DESCRIPTION	SIZE	Pack Count dispenser/carton
1453-01	Adhesive drape sheet, sterile, Blue	100 x 100 cm	13 / 52

Sales Unit: Transport Carton



## evercare<sup>®</sup> Adhesive drape sheet, 75 x 100 cm

REF: 1454-01

evercare<sup>®</sup> Adhesive drape sheet, sterile is a versatile, impervious, absorbent drapes with an adhesive strip for secure adhesion.

### Key Features

- ▶ Impervious
- ▶ Absorbent
- ▶ Secure adhesion
- ▶ Available in several sizes
- ▶ Complies to EN 13795-1 High performance critical product area requirements



75 x 100 cm

REF	DESCRIPTION	SIZE	Pack Count dispenser/carton
1454-01	Adhesive drape sheet, sterile, Blue	75 x 100 cm	15 / 60

Sales Unit: Transport Carton

## evercare<sup>®</sup> Adhesive drape sheet 50 x 60 cm

REF: 1455-01

evercare<sup>®</sup> Adhesive drape sheet, sterile is a versatile, impervious, absorbent drapes with an adhesive strip for secure adhesion.

### Key Features

- ▶ Impervious
- ▶ Absorbent
- ▶ Secure adhesion
- ▶ Available in several sizes
- ▶ Complies to EN 13795-1 High performance critical product area requirements

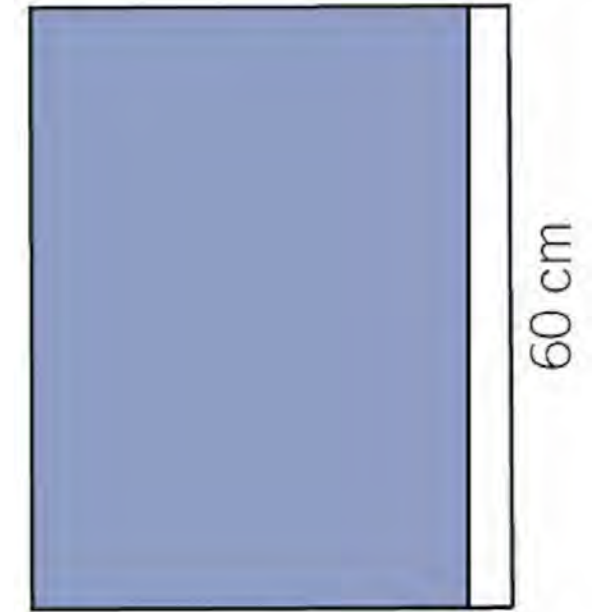

50 cm

REF	DESCRIPTION	SIZE	Pack Count dispenser/carton
1455-01	Adhesive drape sheet, sterile, Blue	50 x 60 cm	40 / 160

Sales Unit: Transport Carton

## evercare<sup>®</sup> Adhesive drape sheet 75 x 90 cm

REF: 1460-02

evercare<sup>®</sup> Adhesive drape sheet, sterile is a versatile, impervious, absorbent drapes with an adhesive strip for secure adhesion.

### Key Features

- ▶ Impervious
- ▶ Absorbent
- ▶ Secure adhesion
- ▶ Available in several sizes
- ▶ Complies to EN 13795-1 High performance critical product area requirements

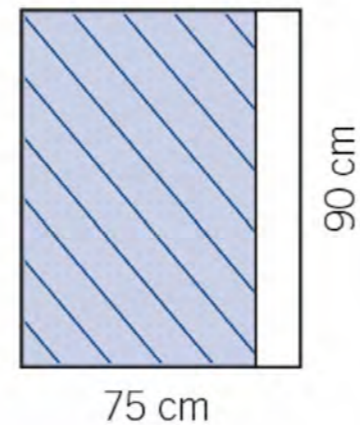

REF	DESCRIPTION	SIZE	Pack Count dispenser/carton
1460-02	Adhesive drape sheet, sterile, Blue	75 x 90 cm	16 / 64

Sales Unit: Transport Carton

## evercare<sup>®</sup> Adhesive drape sheet 75 x 75 cm

REF: 1461-01

evercare<sup>®</sup> Adhesive drape sheet, sterile is a versatile, impervious, absorbent drapes with an adhesive strip for secure adhesion.

### Key Features

- ▶ Impervious
- ▶ Absorbent
- ▶ Secure adhesion
- ▶ Available in several sizes
- ▶ Complies to EN 13795-1 High performance critical product area requirements

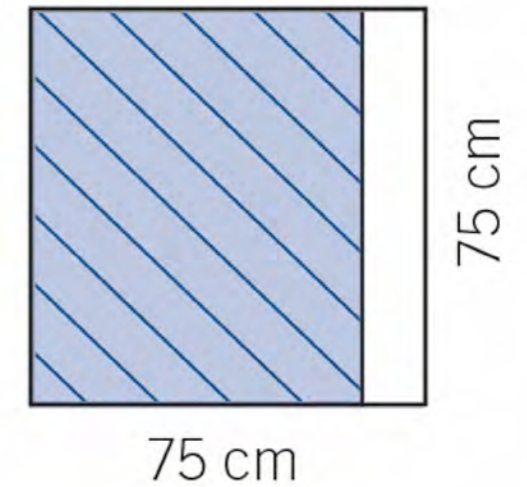

REF	DESCRIPTION	SIZE	Pack Count dispenser/carton
1461-01	Adhesive drape sheet, sterile, Blue	75 x 75 cm	15 / 60

Sales Unit: Transport Carton

## evercare<sup>®</sup> Absorbent drape 70 x 60 cm

REF: 1463-02

evercare<sup>®</sup> Absorbent drape, sterile is a versatile, impervious, extra absorbent drape with an adhesive strip for secure adhesion.

### Key Features

- ▶ Extra absorbent
- ▶ Secure adhesion
- ▶ Complies to EN 13795-1 High performance less critical product area requirements



60 x 70 cm

REF	DESCRIPTION	SIZE	Pack Count dispenser/carton
1463-02	Adhesive absorbent drape, sterile, Blue	70 x 60 cm, Adhesive edge 5 cm	18 / 72

Sales Unit: Transport Carton

## evercare<sup>®</sup> Adhesive drape sheet Medium 180 x 180 cm

REF: 1465-02

evercare<sup>®</sup> Adhesive drape, sterile sheets are made from impervious, absorbent material for patient draping in wide variety of procedures. To enable secure draping done in stages, the peel papers covering the adhesive stripes are divided into parts. These parts are overlapping to allow for easy draping reducing risks.

### Key Features

- ▶ Impervious
- ▶ Absorbent
- ▶ Complies to EN 13795-1 High performance critical product area requirements

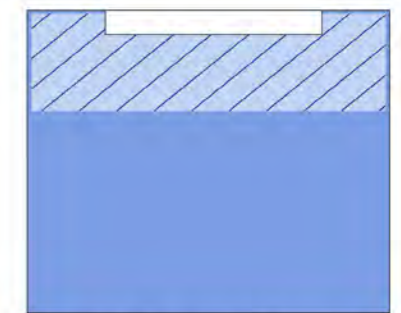

180 x 180 cm

REF	DESCRIPTION	SIZE	Pack Count dispenser/carton
1465-02	Adhesive drape, sterile, Blue	Medium 180 x 180 cm	8 / 32

Sales Unit: Transport Carton

## evercare<sup>®</sup> Adhesive drape sheet, 150 x 175 cm

REF: 1466

evercare<sup>®</sup> Adhesive drape, sterile sheets are made from impervious, absorbent material for patient draping in wide variety of procedures.

### Key Features

- ▶ Impervious
- ▶ Absorbent
- ▶ Complies to EN 13795-1 High performance critical product area requirements

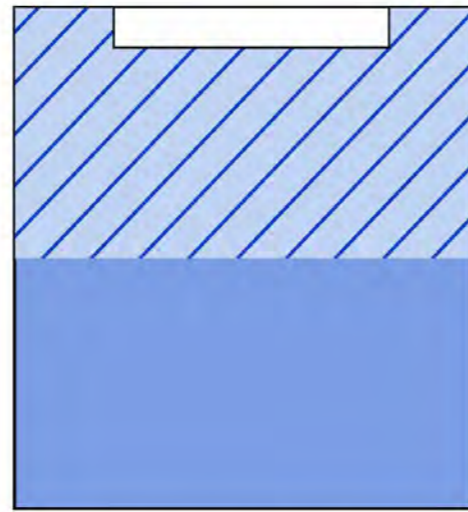

150 x 175 cm

REF	DESCRIPTION	SIZE	Pack Count dispenser/carton
1466	Adhesive drape, sterile, Blue	150 x 175 cm	17 / 34

Sales Unit: Transport Carton

## evercare<sup>®</sup> Adhesive drape sheet Large 150 x 240 cm

REF: 1470-02

evercare<sup>®</sup> Adhesive drape, sterile sheets are made from impervious, absorbent material for patient draping in wide variety of procedures. To enable secure draping done in stages, the peel papers covering the adhesive stripes are divided into parts. These parts are overlapping to allow for easy draping reducing risks.

### Key Features

- ▶ Impervious
- ▶ Absorbent
- ▶ Complies to EN 13795-1 High performance critical product area requirements

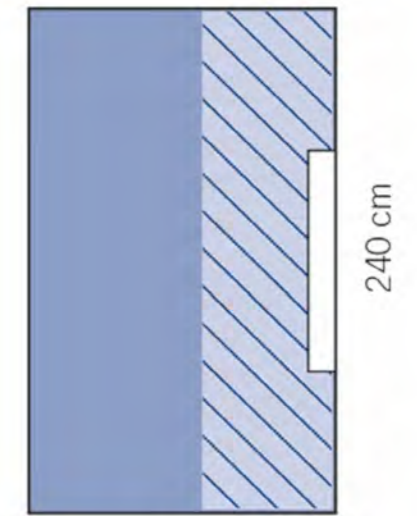

150 cm

240 cm

REF	DESCRIPTION	SIZE	Pack Count dispenser/carton
1470-02	Adhesive drape, sterile, Blue	Large 150 x 240 cm	8 / 32

Sales Unit: Transport Carton

# evercare® Angiography drapes

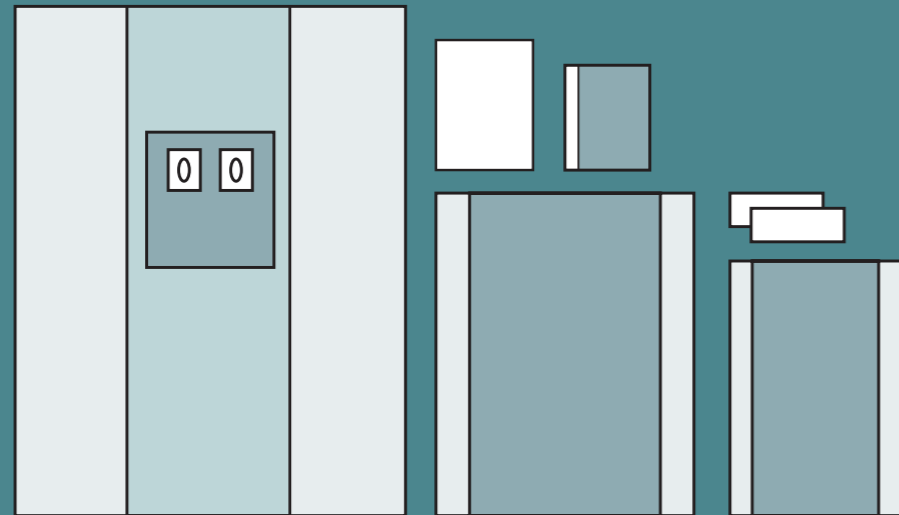

## evercare® Angiography set

REF: 1239-01

evercare® Angiography set, sterile is a set for draping patients and operating units in angiographic procedures.

### Key Features

- ▶ Absorbent patch
- ▶ Adhesive OP Tape
- ▶ Main drape complies to EN 13795-1 High performance critical product area requirements

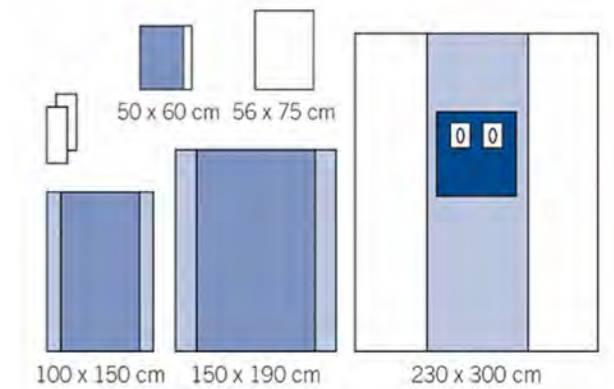

REF	DESCRIPTION	SIZE	Pack Count dispenser/carton
1239-01	Angiography set, sterile	See Material table	10 / 10

Sales Unit: Transport Carton

### Material

Product Part	Raw Material & Characteristics
1 Instrument table cover	100 x 150 cm, Laminate: PP nonwoven/PE film, blue
1 Absorbent sheet,	56 x 75 cm, Spunlaced nonwoven of polyester/pulp viscose, white
2 Hand towel	30 x 34 cm, Pulp, natural white, thread reinforced
1 Adhesive drape sheet	50 x 60 cm, Laminate: PP nonwoven/PE film, blue
1 Angiography drape	230 x 300 cm, Laminate: blue PP nonwoven/transparent PE film, absorbent patch 75 x 70 cm: PP nonwoven
1 Instrument table cover, unfolded	150 x 190 cm, Laminate: PP nonwoven/PE film, blue

## evercare® Angiography set

REF: 1240-02

evercare® Angiography set, sterile is a set for draping patients and operating units in angiographic procedures.

### Key Features

- ▶ Transparent Side panels
- ▶ Absorbent patch
- ▶ Adhesive OP Tape
- ▶ Main drape complies to EN 13795-1 High performance critical product area requirements

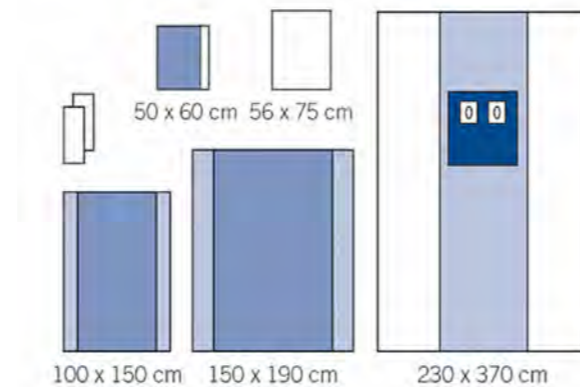

REF	DESCRIPTION	SIZE	Pack Count dispenser/carton
1240-02	Angiography set, sterile	See Material table	5 / 10

Sales Unit: Transport Carton

### Material

Product Part	Raw Material & Characteristics
1 instrument table cover, folded	100 x 150 cm, Laminate: PP nonwoven/PE film, blue
2 Hand towels	30 x 34 cm, Pulp, natural white, thread reinforced
1 Absorbent sheet	56 x 75 cm, Spunlace nonwoven, of polyester/pulp viscose, white
1 Adhesive drape sheet	50 x 60 cm, Laminate: PP nonwoven/polyethylene film, blue
1 Angiography drape	230 x 370 cm, Laminate: PP nonwoven, blue/plastic film, transparent side panels absorbent patch 75 x 70 cm, PP nonwoven, dark blue, apertures 7 x 10 cm

## evercare® Angiography set

REF: 1241-02

evercare® Angiography set, sterile is a set for draping patients and operating units in angiographic procedures.

### Key Features

- ▶ Transparent Side panels
- ▶ Absorbent patch
- ▶ Adhesive OP Tape
- ▶ Main drape complies to EN 13795-1 High performance critical product area requirements

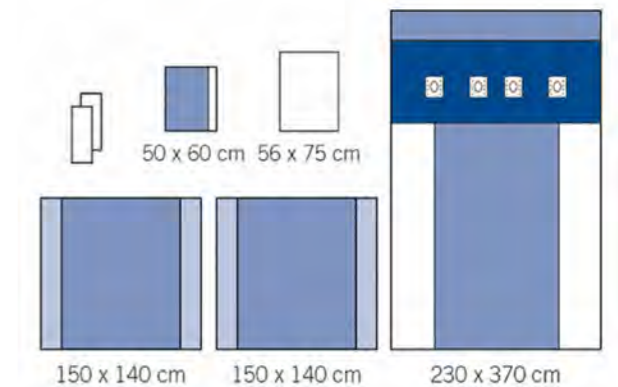

REF	DESCRIPTION	SIZE	Pack Count dispenser/carton
1241-02	Angiography set, sterile	See Material table	4 / 8

Sales Unit: Transport Carton

### Material

Product Part	Raw Material & Characteristics
1 Instrument table cover, folded	140 x 150 cm, Laminate: PP nonwoven/PE film, blue
2 Hand towels	30 x 34 cm, Pulp, natural white, thread reinforced
1 Absorbent sheet	56 x 75 cm, Spunlace nonwoven, of polyester/pulp viscose, white
1 Adhesive drape sheet	50 x 60 cm, Laminate: PP nonwoven/polyethylene film, blue
1 Angiography drape	230 x 370 cm, Laminate: PP nonwoven, blue/plastic film, transparent side panels absorbent patch 230 x 75 cm, PP nonwoven, dark blue, apertures 5 x 7 cm (2 pcs) and 7 x 10 cm (2 pcs)
1 Instrument table cover	150 x 140 cm, Laminate: PP nonwoven/polyethylene film, blue

## evercare® Angiography drape 230 x 300 cm

REF: 1340-01

evercare® Angiography drape, sterile is an all-in-one drape with a reinforced area around the two off-center fenestrations and transparent side panels. Used in angiographic procedures.

### Key Features

- ▶ All-in-one drape
- ▶ Reinforced area
- ▶ Transparent side panels
- ▶ Complies to EN 13795-1 High performance critical product area requirements

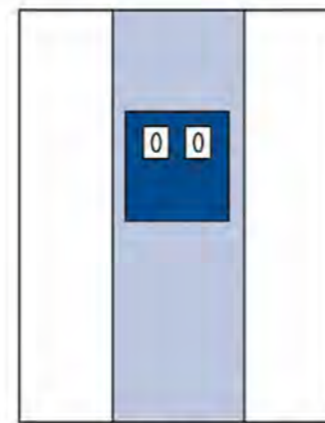

230 x 300 cm

REF	DESCRIPTION	SIZE	Pack Count dispenser/carton
1340-01	Angiography drape, transparent side panels, absorbent patch, apertures, sterile, Blue/Transparent	230 x 300 cm, absorbent patch 75 x 70 cm, apertures 7 x 10 cm	15 / 30

Sales Unit: Transport Carton



# evercare<sup>®</sup> ENT Dental drapes

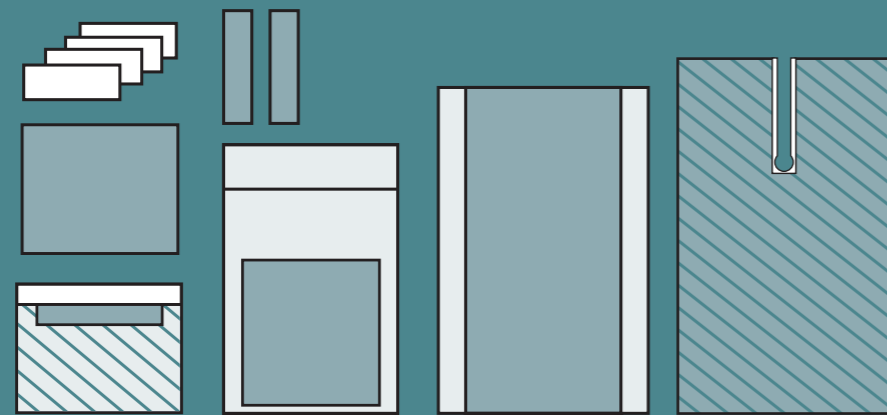

## evercare<sup>®</sup> ENT set

REF: 1238-03

evercare<sup>®</sup> ENT set, sterile is a versatile and practical set for operations of the ear/nose/throat area. Non-reinforced drape for comfortability.

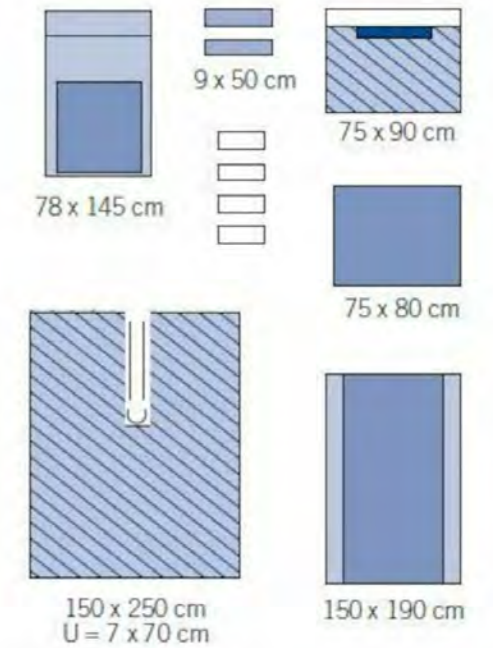

### Key Features

- ▶ Absorbent patch
- ▶ Adhesive OP Tape
- ▶ Main drape complies to EN 13795-1 High performance critical product area requirements

REF	DESCRIPTION	SIZE	Pack Count dispenser/carton
1238-03	ENT set, sterile	See Material table	5 / 10

Sales Unit: Transport Carton

### Material

Product Part	Raw Material & Characteristics
4 Hand towels	30 x 34 cm, Pulp, natural white, thread reinforced
1 Mayo cover	78 x 145 cm, Laminate: PP nonwoven/PE film/PE-film, blue
2 Adhesive Op-tapes	9 x 50 cm, Nonwoven polyester, blue, adhesive coated
1 Adhesive drape	75 x 90 cm, Laminate: blue PP nonwoven/blue PE film/white PP nonwoven, absorbent patch 15 x 50 cm blue PET nonwoven
1 Utility drape	75 x 80 cm, Laminate: PP nonwoven/PE film, blue
1 Adhesive split sheet	150 x 250 cm, Laminate: blue PP nonwoven/blue PE film/white PP nonwoven, split 7 x 70 cm
1 Instrument table cover	150 x 190 cm, Laminate: PP nonwoven/PE film, blue



## evercare<sup>®</sup> Dental set

REF: 1288-01

evercare<sup>®</sup> Dental set, sterile is a draping set for dental/oral surgery.

### Key Features

- ▶ Tube covers
- ▶ Adhesive OP Tape
- ▶ Main drape complies to EN 13795-1 High performance critical product area requirement

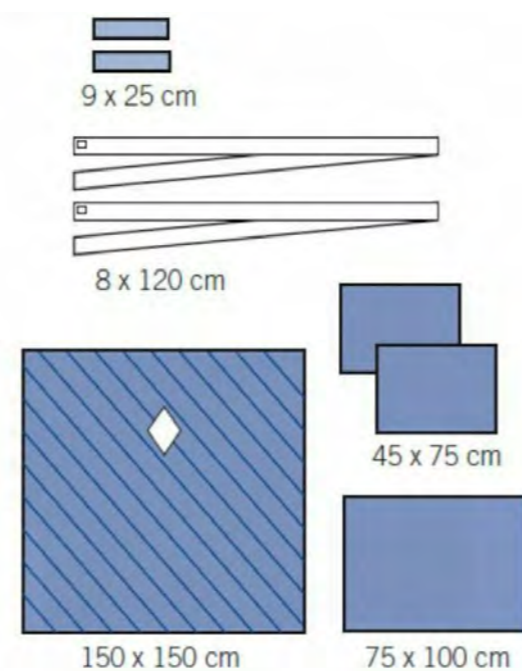

REF	DESCRIPTION	SIZE	Pack Count dispenser/carton
1288-01	Dental set, sterile	See Material table	9 / 36

Sales Unit: Transport Carton

### Material

Product Part	Raw Material & Characteristics
1 Dental drape	150 x 150 cm, laminate: blue PP nonwoven/blue PE-film film/white pp nonwoven, diamond shaped aperture
2 Adhesive Op-tape	9 x 25 cm, Nonwoven polyester, blue, adhesive coated
2 Tube covers	8 x 120 cm, transparent polyethylene
2 Utility drapes	45 x 75 cm, laminate: blue PP nonwoven/blue PE-film
1 Instrument table cover	75 x 100 cm, PP nonwoven/polyethylene film laminate, blue

## evercare<sup>®</sup> Dental set

REF: 1290-02

evercare<sup>®</sup> Dental set, sterile has a convenient aperture shape for optimal access to the oral area. Comfort layer to assure softness towards skin. 100% impermeable.

### Key Features

- ▶ Tube covers
- ▶ Adhesive OP Tape
- ▶ Main drape complies to EN 13795-1 High performance critical product area requirement

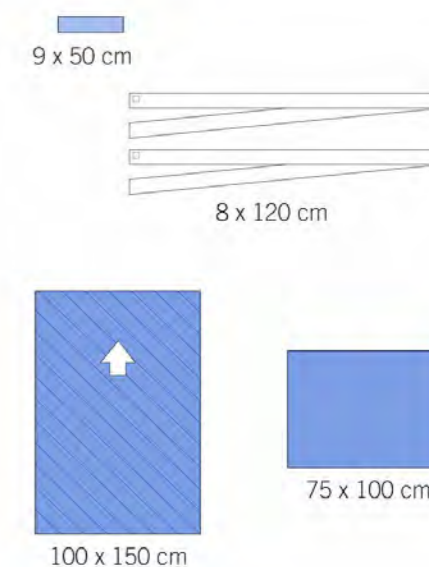

REF	DESCRIPTION	SIZE	Pack Count dispenser/carton
1290-02	Dental set, sterile	See Material table	14 / 56

Sales Unit: Transport Carton

### Material

Product Part	Raw Material & Characteristics
1 Dental drape	100 x 150 cm, blue PP nonwoven/blue PE-film/white PP nonwoven, triangular shaped aperture
1 Adhesive Op-tape	9 x 50 cm, Nonwoven polyester, blue, adhesive coated
2 Tube covers	8 x 120 cm, transparent PE-film
1 Instrument table cover	75 x 100cm, PP nonwoven/PE-film laminate, blue

# evercare® Gynae and Uro drapes & sets

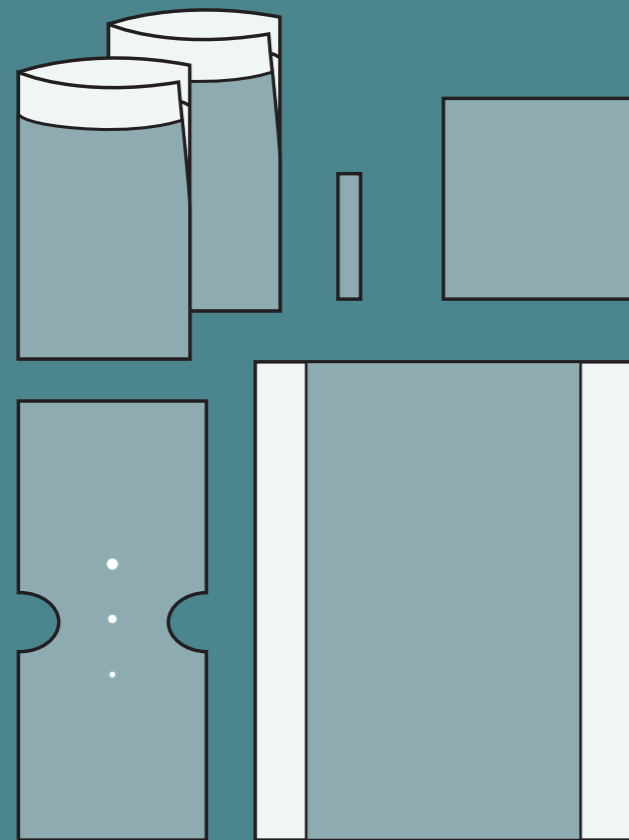

## evercare® Gynae/cyst set

REF: 1250-01

evercare® Gynae/cyst set, sterile is a flexible set for cystoscopies and gynaecological procedures.

### Key Features

- ▶ 2 Leggings
- ▶ Main drape complies to EN 13795-1 High performance critical product area requirements

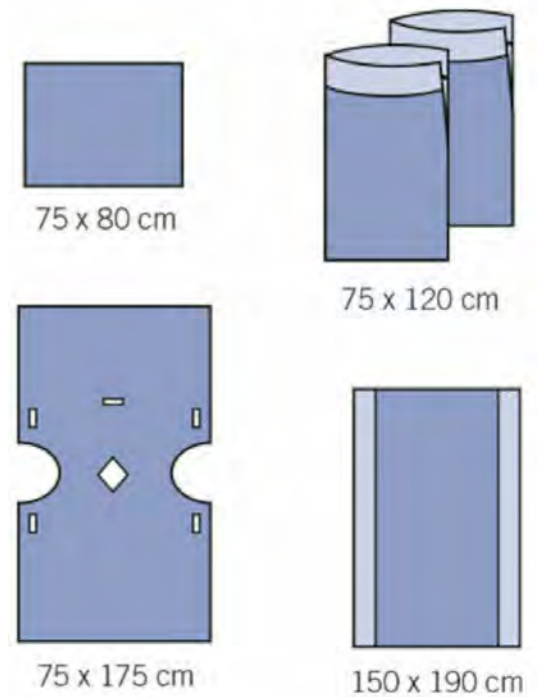

REF	DESCRIPTION	SIZE	Pack Count dispenser/carton
1250-01	Gynae/cyst set, sterile	See Material table	5 / 20

Sales Unit: Transport Carton

### Material

Product Part	Raw Material & Characteristics
1 Utility drape	75 x 80 cm, Laminate: PP nonwoven/PE –film, blue
2 Leggings	75 x 120 cm, Laminate: PP nonwoven/PE –film, blue
1 Gyn/cyst drape	75 x 175 cm, Laminate: PP nonwoven/PE –film, blue, aperture 9 x 15 cm
1 Instrument table cover	150 x 190 cm, Laminate: PP nonwoven/PE –film, blue

## evercare® Gynaecology set

REF: 1251-02

evercare® Gynaecology set, sterile is a draping set for intravaginal and transvaginal procedures, e.g. in vaginoplasty and colpoperineoplasty, in vaginal uterus extirpation or in colposuspension to eliminate incontinence.

### Key Features

- ▶ Fluid collection pouch
- ▶ Absorbent patch
- ▶ Integrated Leggings
- ▶ Adhesive OP Tape
- ▶ Main drape complies to EN 13795-1 High performance critical product area requirements

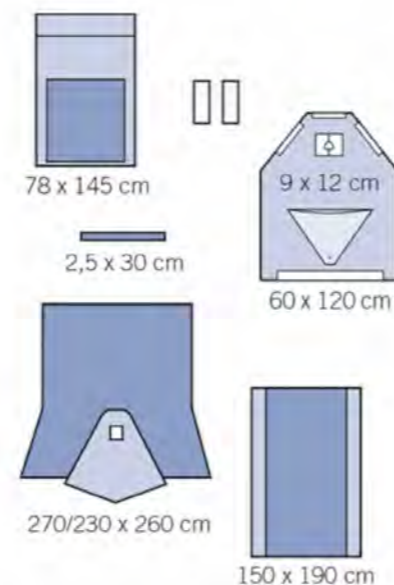

REF	DESCRIPTION	SIZE	Pack Count dispenser/carton
1251-02	Gynaecology set, sterile	See Material table	6 / 12

Sales Unit: Transport Carton

### Material

Product Part	Raw Material & Characteristics
1 Mayo cover	78 x 145 cm, reinforced, Laminate: PP nonwoven/PE-film/PE-film, blue, absorbent patch 65 x 85 cm
2 Hand towels	30 x 34 cm, pulp, natural white, thread reinforced
1 Tube holder	2,5 x 30 cm, Loop white nylon knit loop on a polyethylene film base, hook white polyethylene
1 Gynaecology drape	60 x 120 cm, aperture 9 x 12 cm, adhesives for fixation, laminate: PP nonwoven/PE film, blue fluid collection pouch transparent polyethylene vinyl acetate,
1 Gynaecology drape	270/230 x 260 cm, aperture 24 x 21 cm, integrated leggings, laminate: PP nonwoven/PE film, blue,
1 Instrument table cover	150 x 190 cm, laminate: PP nonwoven/PE film, blue

## evercare® Gynaecology and Urology set

REF: 1252

evercare® Gynaecology and Urology set, sterile has an all-in-one T-sheet with tube holders and integrated fluid pouch. Table and Mayo -cover are included. It has a low particle release (linting).

### Key Features

- ▶ Fluid collection pouch
- ▶ Tube holders
- ▶ Main drape complies to EN 13795-1 High performance critical product area requirements

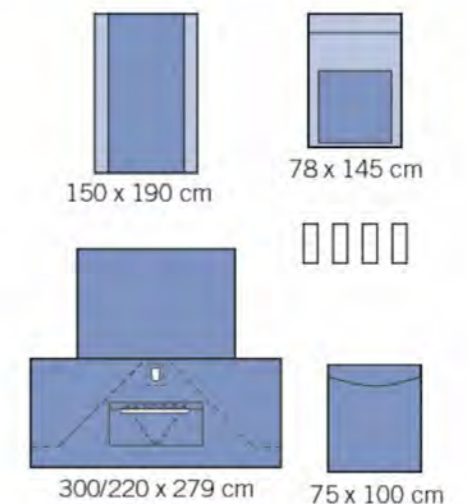

REF	DESCRIPTION	SIZE	Pack Count dispenser/carton
1252	Gynaecology and Urology set, sterile	See Material table	0 / 7

Sales Unit: Transport Carton

### Material

Product Part	Raw Material & Characteristics
1 Mayo cover	78 x 145 cm, reinforced, PP nonwoven /polyethylene film laminate, blue
4 Hand towels	30 x 34 cm, Pulp, natural white, thread reinforced
1 Under buttock drape	75 x 100 cm, PP nonwoven/PE film laminate
1 Uro/Gyn drape	300/220 x 279 cm, PP nonwoven/PE film laminate, blue PE film, blue fluid collection pouch PE/EVA film, transparent edging foam PU, blue tube holders
1 Instrument table cover	150 x 190 cm PP nonwoven/polyethylene film laminate, blue

## evercare® Gynaecology set

REF: 1253-01

evercare® Gynaecology set, sterile is a draping set for gynaecological procedures.

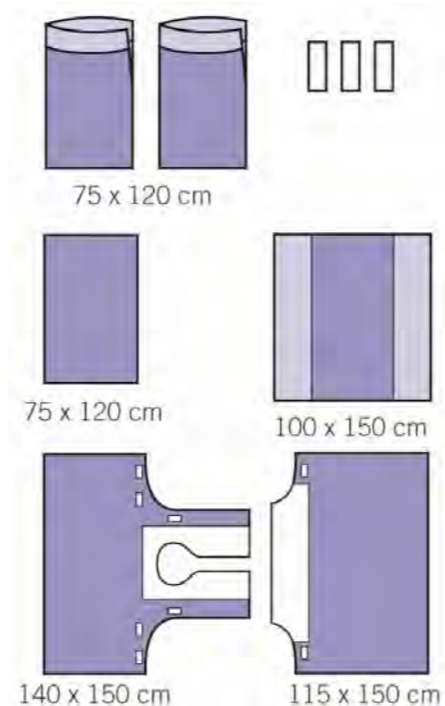

### Key Features

- ▶ 2 Leggings
- ▶ Main drape complies to EN 13795-1 High performance critical product area requirements

REF	DESCRIPTION	SIZE	Pack Count dispenser/carton
1253-01	Gynaecology set, sterile	See Material table	4 / 16

Sales Unit: Transport Carton

### Material

Product Part	Raw Material & Characteristics
3 Hand towels	20 x 34 cm, Pulp, natural white, thread reinforced
1 Utility drape	75 x 120 cm, Laminate: PP nonwoven/PE film, blue
2 Leggings	75 x 120 cm, Laminate: PP nonwoven/PE film, blue
1 Gyn upper drape	115 x 150 cm, Laminate: PP nonwoven/PE film, blue
1 Gyn lower drape	140 x 150 cm, Laminate: PP nonwoven/PE film, blue
1 Instrument table cover	100 x 150 cm, Laminate: PP nonwoven/PE film, blue

## evercare® Delivery set

REF: 1255-01

evercare® Delivery set, sterile is a disposable delivery set for vaginal deliveries.

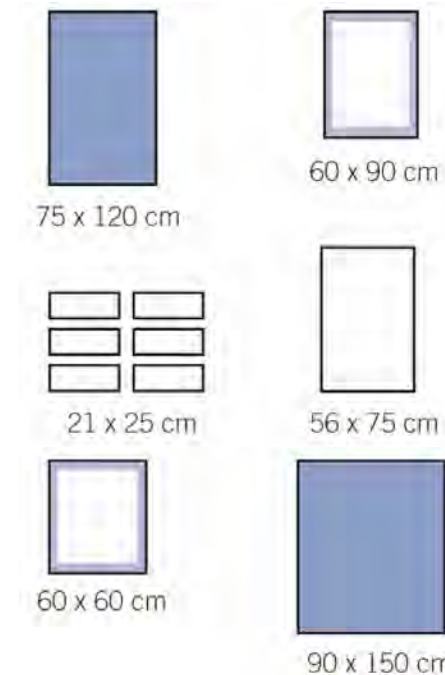

### Key Features

- ▶ Main drape complies to EN 13795-1 High performance critical product area requirement

REF	DESCRIPTION	SIZE	Pack Count dispenser/carton
1255-01	Delivery set, sterile	See Material table	0 / 12

Sales Unit: Transport Carton

### Material

Product Part	Raw Material & Characteristics
1 Universal cover drape (for under the mother)	90 x 150 cm, Laminate: PP nonwoven/PE film, blue
1 Utility drape (stitching sheet)	75x120 cm, PP nonwoven/PE film, blue
1 Bed pad	60 x 90 cm, Coverstock CV nonwoven white, fluff 100 % pulp white, PE-film green
1 Absorbent sheet (baby sheet)	56x 75 cm, PP nonwoven, white
6 Hand towels	21 x 25 cm, PP nonwoven, white
1 Bed pad	60 x 60 cm, Coverstock CV nonwoven white, fluff 100 % pulp white, PE-film green

## evercare® C-section set, incision film

REF: 1261-02

evercare® C-section set, sterile is an all-in-one C-section solution for fast draping. Integrated fluid collection pouch with tube holders and integrated incision film.

### Key Features

- ▶ Incision film
- ▶ Fluid collection pouch
- ▶ Tube holders
- ▶ Adhesive OP Tape
- ▶ Main drape complies to EN 13795-1 High performance critical product area requirement

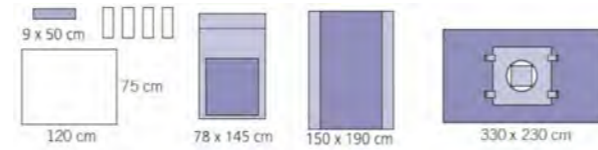

REF	DESCRIPTION	SIZE	Pack Count dispenser/carton
1261-02	C-section set, sterile	See Material table	5 / 10

Sales Unit: Transport Carton

### Material

Product Part	Raw Material & Characteristics
1 Mayo stand cover	78 x 145 cm, reinforced, PP nonwoven, plastic laminate/polyethylene film laminate, blue, absorbent patch 65 x 85 cm
4 Hand towels	30 x 34 cm, Pulp, natural white, thread reinforced
1 Op-tape	9 x 50 cm, Nonwoven polyester, blue, adhesive coated
1 baby sheet	75 x 120 cm, PP nonwoven, white
1 C-section drape	330x 230 cm: PP nonwoven/polyethylene film laminate, blue integrated fluid collection pouch and tube holders: PE/EVA film, transparent edging foam PU, blue integrated incision film aperture 36 x 36 cm: adhesive coated polyethylene film
1 Instrument table cover	150 x 190 cm, PP nonwoven/polyethylene film laminate, blue

## evercare® TUR set

REF: 1270-02

evercare® TUR set, sterile is a flexible set for TUR procedures.

### Key Features

- ▶ Rectal examination finger cot
- ▶ 2 Leggings
- ▶ Adhesive OP Tape
- ▶ Main drape complies to EN 13795-1 High performance critical product area requirement

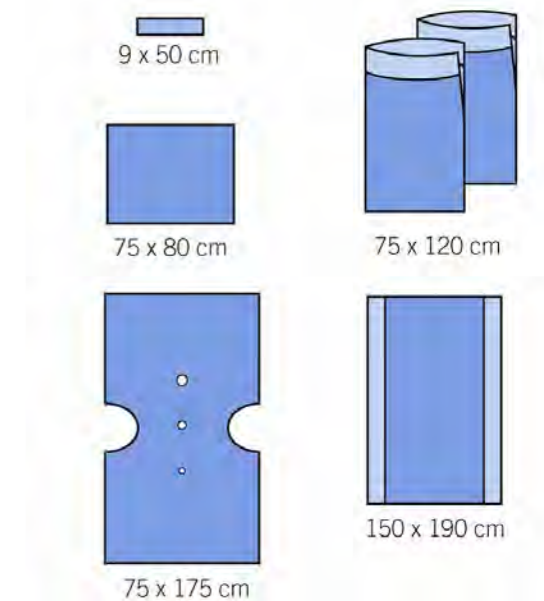

REF	DESCRIPTION	SIZE	Pack Count dispenser/carton
1270-02	TUR set, sterile	See Material table	4 / 16

Sales Unit: Transport Carton

### Material

Product Part	Raw Material & Characteristics
1 Adhesive Op-tape	9 x 50 cm, Nonwoven polyester, blue, adhesive coated
1 Utility drape	75 x 80 cm, Laminate: PP nonwoven/PE-film, blue
2 Leggings	75 x 120 cm, Laminate: PP nonwoven/PE-film, blue
1 TUR drape	75 x 175 cm, Laminate: PP nonwoven/polyethylene film, blue finger cot: vinyl
1 Instrument table cover	150 x 190 cm, Laminate: PP nonwoven/PE film, blue

## evercare® TUR set

REF: 1272-01

evercare® TUR set, sterile containing items needed for patient draping in TUR-procedures.

### Key Features

- ▶ Rectal examination finger cot
- ▶ Fluid collection pouch
- ▶ Tube holders
- ▶ Adhesive OP Tape
- ▶ Main drape complies to EN 13795-1 High performance critical product area requirement

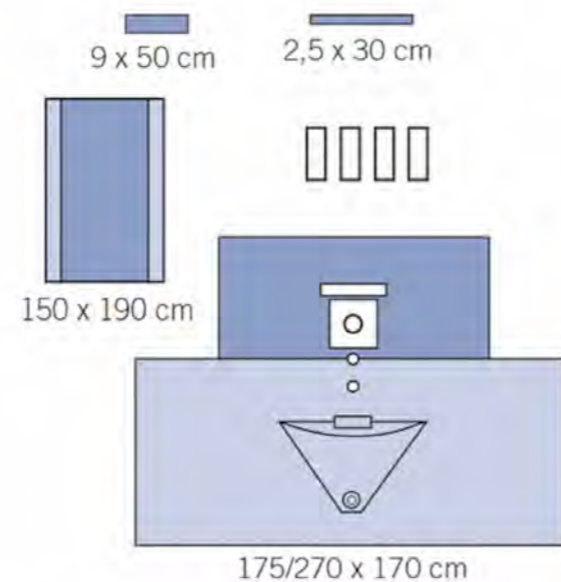

REF	DESCRIPTION	SIZE	Pack Count dispenser/carton
1272-01	TUR set, sterile	See Material table	6 / 12

Sales Unit: Transport Carton

### Material

Product Part	Raw Material & Characteristics
1 Hand towels	30 x 34 cm, pulp, natural white, thread reinforced
1 Adhesive Op-tape	9 x 50 cm, Nonwoven polyester, blue, adhesive coated
1 Tube holder	2,5 x 30 cm, Loop white nylon knit loop on a polyethylene film base, hook white polyethylene
1 TUR-drape	175/270 x 170 cm, all-in-one, integrated finger cot and fluid collection pouch with sieve and outlet, aperture Ø 6 cm and Adhesive aperture Ø 8 cm. Laminate: PP nonwoven/polyethylene film, blue finger cot: vinyl, fluid collection pouch with sieve: transparent polyethylene vinyl acetate film
1 Instrument table cover	150 x 190 cm, Laminate: PP nonwoven/polyethylene film, blue

## evercare® Epidural drape 75 x 80 cm, aperture 6 x 15 cm

REF: 1510-01

evercare® Epidural drape, sterile with adhesive aperture provides easy and quick draping for a variety of procedures.

### Key Features

- ▶ Easy and quick draping
- ▶ Complies to EN 13795-1 High performance critical product area requirements

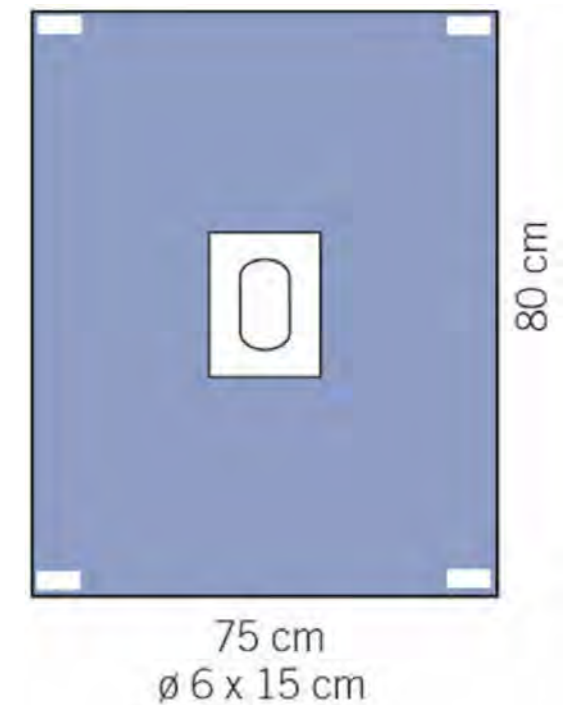

REF	DESCRIPTION	SIZE	Pack Count dispenser/carton
1510-01	Epidural drape, sterile, Blue	75 x 80 cm, Ø 6 x 15 cm	25 / 100

Sales Unit: Transport Carton

# evercare® Laparoscopy drapes & sets

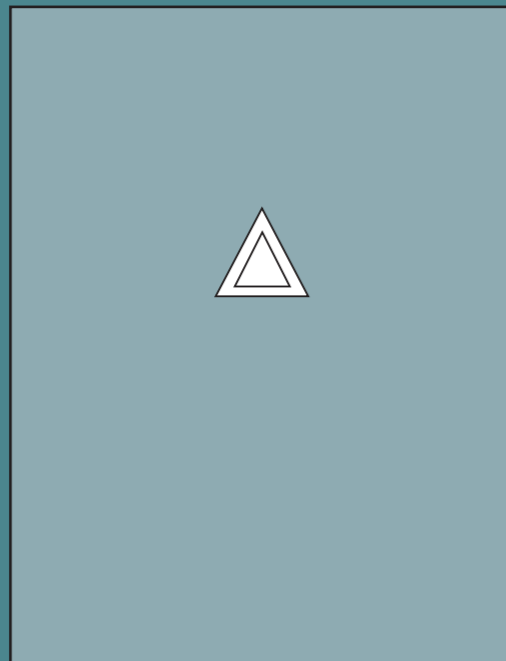

## evercare® Laparoscopy set

REF: 1267-02

evercare® Laparoscopy set, sterile is a practical set for draping different types of laparoscopies.

### Key Features

- ▶ Absorbent patch
- ▶ Tube holders
- ▶ Adhesive OP Tape
- ▶ Main drape complies to EN 13795-1 High performance critical product area requirement

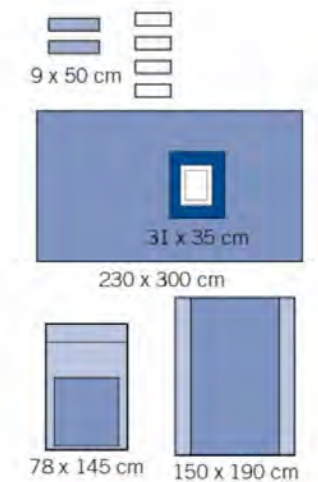

REF	DESCRIPTION	SIZE	Pack Count dispenser/carton
1267-02	Laparoscopy set, sterile	See Material table	7 / 14

Sales Unit: Transport Carton

### Material

Product Part	Raw Material & Characteristics
4 Hand towels	30 x 34 cm, Pulp, natural white, thread reinforced
1 Mayo cover	78 x 145 cm, reinforced, PP nonwoven/PE-film/PE-film, blue
2 Adhesive OP-tape	9 x 50 cm, Nonwoven polyester, blue, adhesive coated
1 Utility drape	75 x 80 cm, PP nonwoven/PE-film, blue
1 Laparoscopy drape	230 x 300 cm, PP nonwoven, blue/PE-film blue/PP nonwoven, white blue absorbent patch 75 x 80 cm, PP nonwoven, tube holder, aperture 31 x 35 cm
1 Instrument table cover	150 x 190 cm, PP nonwoven/polyethylene film, blue

evercare<sup>®</sup> Laparoscopy drape 230 x 300 cm, aperture 25 x 20 cm, triangle

REF: 1365-01

evercare<sup>®</sup> Laparoscopy drape, sterile is an all-in-one surgical drapes for laparoscopic procedures.

### Key Features

- ▶ All-in-one drape
- ▶ Reinforced area
- ▶ Transparent side panels
- ▶ Complies to EN 13795-1 High performance critical product area requirements



REF	DESCRIPTION	SIZE	Pack Count dispenser/carton
1365-01	Laparoscopy drape with triangular aperture, sterile, Blue	230 x 300 cm, triangle 25 x 20 cm	9 / 18

Sales Unit: Transport Carton

evercare<sup>®</sup> Laparoscopy drape 230x300 cm aperture 20x31 cm

REF: 1366-01

evercare<sup>®</sup> Laparoscopy drape, sterile is an all-in-one surgical drapes for laparoscopic procedures.

### Key Features

- ▶ All-in-one drape
- ▶ Complies to EN 13795-1 High performance critical product area requirements



REF	DESCRIPTION	SIZE	Pack Count dispenser/carton
1366-01	Laparoscopy drape with rectangular aperture, sterile, Blue	230 x 300 cm, triangle 20x31 cm	9 / 18

Sales Unit: Transport Carton



# evercare<sup>®</sup> OP tape

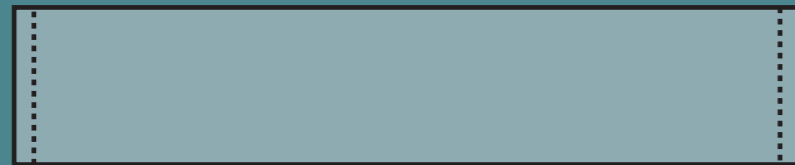

## evercare<sup>®</sup> Adhesive impermeable OP-tape 9 x 50 cm

REF: 1494

evercare<sup>®</sup> Adhesive OP-tape impermeable, disposable, sterile is a multi-functional tape for fixations during surgical procedures. It is made of the same nonwoven material widely used for surgical clothing. PE-film layered on the nonwoven material ensures fluid impermeability.

### Key Features

- ▶ Impermeable to prevent fluid strikethrough
- ▶ For fixation of drapes and tubing during surgical procedures
- ▶ Sterile
- ▶ Complies to EN 13795-1 High performance critical product area requirements



9 x 50 cm

REF	DESCRIPTION	SIZE	Pack Count dispenser/carton
1494	Adhesive OP-tape,impermeable, sterile, Blue	9 x 50 cm	100 / 400

Sales Unit: Transport Carton

## evercare<sup>®</sup> Adhesive OP-tape, 9 x 50 cm

REF: 1495-02, 1496-02

evercare<sup>®</sup> OP-tape, sterile is a handy component for fixation of drapes, tubings etc. during surgical procedures.



9 x 50 cm

### Key Features

- ▶ Fixation of drapes, tubings etc
- ▶ Blue
- ▶ 2-pack

REF	DESCRIPTION	SIZE	Pack Count dispenser/carton
1495-02	OP-tape, 1 pcs, sterile, Blue	9 x 50 cm	100 / 400
1496-02	OP-tape, 2 pcs, sterile, Blue	9 x 50 cm	120 / 480

Sales Unit: Transport Carton



# evercare® Ophthalmic drapes & sets

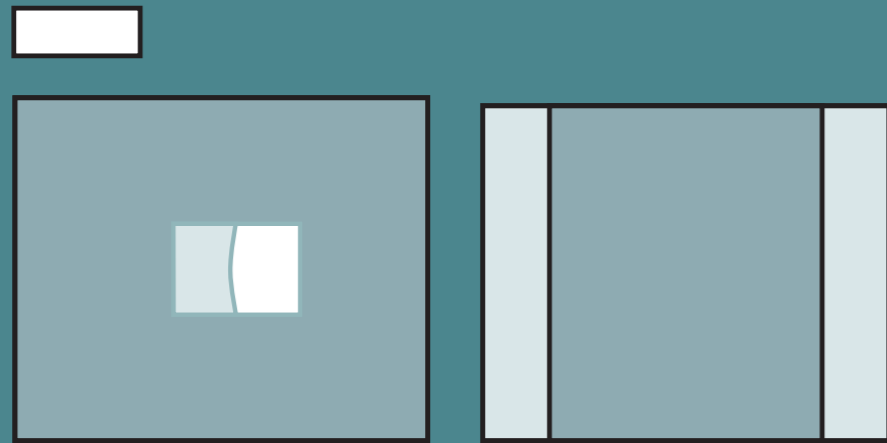

## evercare® Ophthalmic set, incision film

REF: 1280-01

evercare® Ophthalmic set with integrated incision film, sterile contains an impermeable eye drape for efficient infection control. It has an integrated pouch for fluid handling and a flexible wire to maintain wanted shape in fluid collection pouch. Also equipped with incise film in the aperture field to provide full access.

### Key Features

- ▶ Incision film
- ▶ Fluid collection pouch
- ▶ Main drape complies to EN 13795-1 High performance critical product area requirement

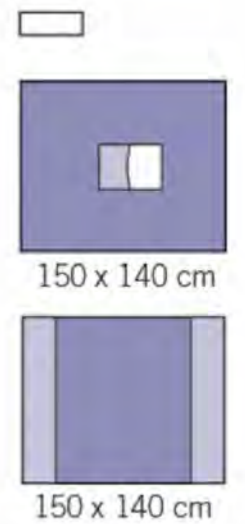

REF	DESCRIPTION	SIZE	Pack Count dispenser/carton
1280-01	Ophthalmic set with integrated incision film, sterile	See Material table	7 / 28

Sales Unit: Transport Carton

### Material

Product Part	Raw Material & Characteristics
1 Hand towel	30 x 34 cm, Pulp, natural white, thread reinforced
1 Ophthalmic drape, with incision film	150 x 140 cm, laminate: PP nonwoven / PE-film blue Fluid collection pouch: PE/EPA-film, transparent Metal wire coated with PE, blue Incision film: adhesive coated polyethylene film
1 Instrument table cover	150 x 140 cm, laminate: PP nonwoven / PE-film, blue

## evercare® Ophthalmic set, 2 fluid collection pouches

REF: 1282-01

evercare® Ophthalmic set, sterile is a sterile draping for ophthalmic surgery.

### Key Features

- ▶ Transparent film dressing
- ▶ Fluid collection pouch
- ▶ Main drape complies to EN 13795-1 High performance critical product area requirement

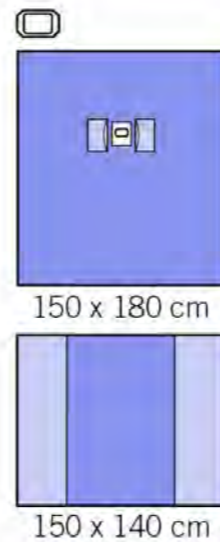

REF	DESCRIPTION	SIZE	Pack Count dispenser/carton
1282-01	Ophthalmic set with 2 fluid collection pouches, separate transparent film dressing, sterile	See Material table	7 / 28

Sales Unit: Transport Carton

### Material

Product Part	Raw Material & Characteristics
1 Transparent film dressing	10 x 12 cm, polyurethane
1 Ophthalmic drape	150 x 180 cm, laminate: blue PP nonwoven/blue PE-film film, oval aperture 5 x 7 cm Fluid collection pouches: LDPE/LLDPE/EPA
1 Instrument Table cover 150 x 140 cm	laminate: blue PP nonwoven/blue PE-film



# evercare® Orthopaedic drapes & sets

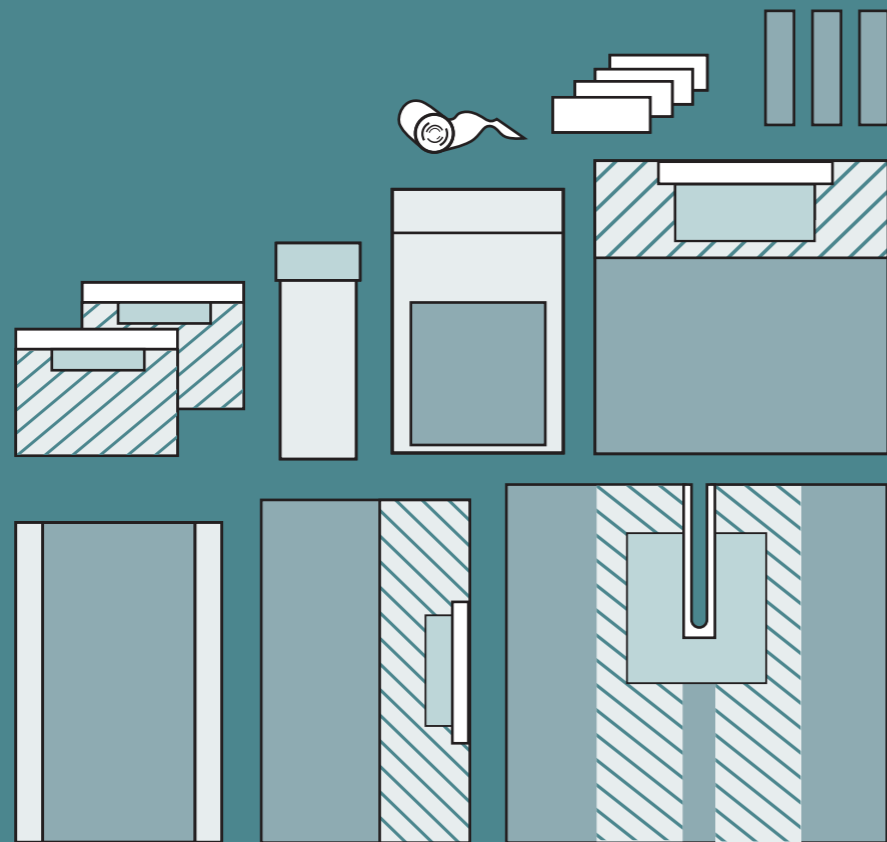

## evercare® Hip set

REF: 1205-01

evercare® Hip set, sterile is a draping set containing draping materials for hip operations.

### Key Features

- ▶ Absorbent patch
- ▶ Stockinette
- ▶ Tube holders
- ▶ Adhesive OP Tape
- ▶ Main drape complies to EN 13795-1 High performance critical product area requirements

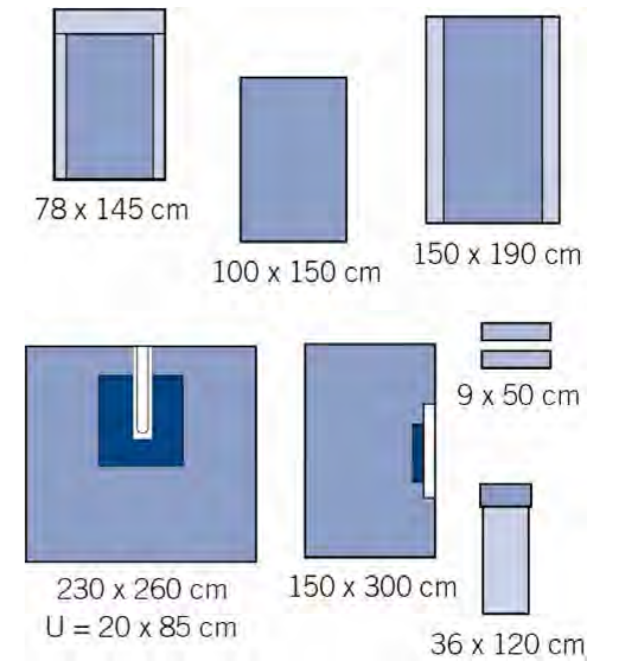

REF	DESCRIPTION	SIZE	Pack Count dispenser/carton
1205-01	Hip set, sterile	See Material table	4 / 8

Sales Unit: Transport Carton

### Material

Product Part	Raw Material & Characteristics
1 Mayo cover	78 x 145 cm, reinforced, Laminate: blue PP nonwoven/blue-white PE-film/blue PE-film
1 Utility drape	100 x 150 cm, Laminate: blue PP nonwoven/blue PE film
2 Adhesive OP-tapes	9 x 50 cm, Nonwoven polyester, blue, adhesive coated
1 Stockinette	36 x 120 cm, Laminate: blue PP nonwoven/blue PE film
1 Adhesive split sheet	230 x 260 cm, Laminate: blue PP nonwoven/blue PE-film, absorbent patch 100 x 50 cm, blue PP nonwoven, split 20 x 85 cm, tube holders
1 Adhesive drape	150 x 300 cm, Laminate: blue PP nonwoven/blue PE-film, blue absorbent patch 15 x 50 cm, PP nonwoven, tube holders
1 Instrument table cover	150 x 190 cm, Laminate: blue PP nonwoven/blue PE-film

## evercare<sup>®</sup> Hip set standard

REF: 1210-02

evercare<sup>®</sup> Hip set standard, sterile is a draping set containing materials for hip operations. The component in size 180 x 180 cm and 150 x 240 cm are designed with adhesive tape with cut peel-papers in shorter length to ease the draping and allow sequenced covering.

### Key Features

- ▶ Absorbent patch
- ▶ Elastic stockinette
- ▶ Tube holders
- ▶ Adhesive OP Tapes
- ▶ Bandage
- ▶ Main drape complies to EN 13795-1 High performance critical product area requirements

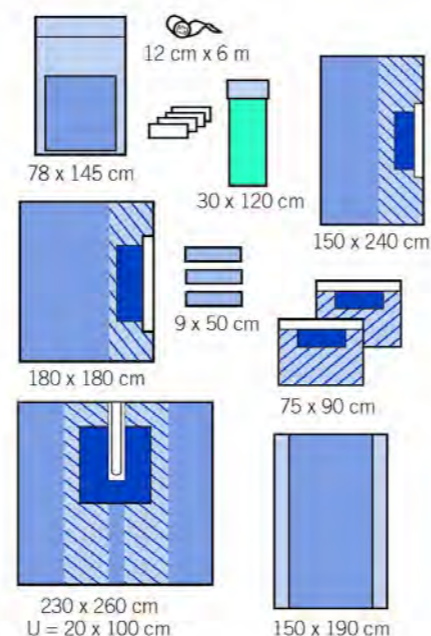

REF	DESCRIPTION	SIZE	Pack Count dispenser/carton
1210-02	Hip set standard, sterile	See Material table	3 / 6

Sales Unit: Transport Carton

## Material

Product Part	Raw Material & Characteristics
<b>1 Mayo cover</b>	78 x 145 cm, reinforced, Laminate: blue PP nonwoven/blue-white PE-film/blue PE-film
<b>4 Hand towels</b>	30 x 34 cm, Pulp, natural white, thread reinforced
<b>1 Adhesive drape medium</b>	180 x 180 cm, Laminate: blue PP nonwoven/blue PE-film/white PP nonwoven, blue absorbent patch 25 x 60 cm, PP nonwoven, tube holders
<b>1 Elastic stockinette</b>	30 x 120 cm, SEBS based thermoplastic elastomer/PES lining
<b>1 Elastic support bandage</b>	12 cm x 6 m PET/cotton
<b>2 Adhesive drape sheets</b>	75 x 90 cm, Laminate: blue PP nonwoven/blue PE-film/white PP nonwoven, blue absorbent patch 25 x 60 cm, PP nonwoven
<b>3 Adhesive Op-tapes</b>	9 x 50 cm, Nonwoven polyester, blue, adhesive coated
<b>1 Adhesive split sheet</b>	230 x 260 cm, Laminate: blue PP nonwoven/blue PE-film/white PP nonwoven, absorbent patch blue 140 x 75 cm, PP nonwoven, split 20 x 100, Tube holders
<b>1 Adhesive drape large</b>	150 x 240 cm, Laminate: blue PP nonwoven/blue PE-film/white PP nonwoven, blue absorbent patch 25 x 60 cm, PP nonwoven, tube holders
<b>1 Instrument table cover</b>	150 x 190 cm, Laminate: blue PP nonwoven/blue PE-film

## evercare® Vertical drape Small

REF: 1330-02

evercare® Vertical drape with fluid collection pouches are a surgical drape that provides a vertical barrier to keep the C-arm isolated from the sterile surgical field during hip/femur fracture or trauma procedures. Sterile.

### Key Features

- ▶ Fluid collection pouch
- ▶ Suction and diathermy pouch
- ▶ Incision film
- ▶ Complies to EN 13795-1 High performance critical product area requirements

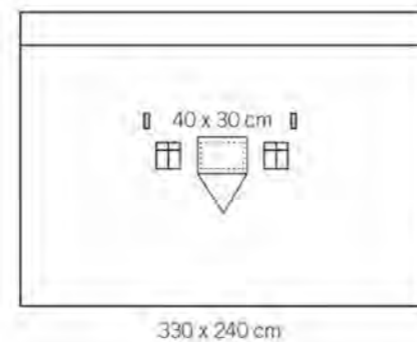

REF	DESCRIPTION	SIZE	Pack Count dispenser/carton
1330-02	Vertical drape with integrated incision film, fluid collection and diathermy pouches, sterile, Transparent	330 x 240 cm, aperture 40 x 30 cm, pouches 24x 24 cm	14 / 28

Sales Unit: Transport Carton

## evercare® Vertical drape Large

REF: 1332-02

evercare® Vertical drape with small fluid collection pouch are a surgical drape that provides a vertical barrier to keep the C-arm isolated from the sterile surgical field during hip/femur fracture or trauma procedures. Sterile.

### Key Features

- ▶ Fluid collection pouch
- ▶ Suction and diathermy pouch
- ▶ Incision film
- ▶ Complies to EN 13795-1 High performance critical product area requirements

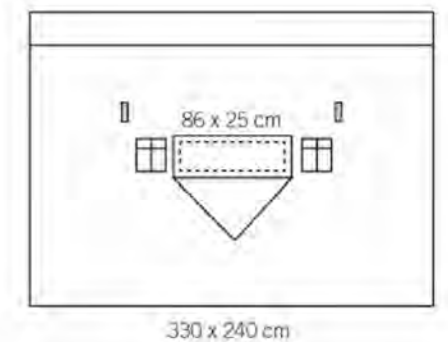

REF	DESCRIPTION	SIZE	Pack Count dispenser/carton
1332-02	Vertical drape with integrated incision film, fluid collection and diathermy pouches, sterile, Transparent	330 x 240 cm, aperture 86 x 25 cm, pouches 24x 24 cm	10 / 20

Sales Unit: Transport Carton

## evercare® Vertical drape set small

REF: 1225-02

evercare® Vertical drape set, small, sterile is a surgical draping set that provides a vertical barrier to keep the C-arm isolated from the sterile surgical field during hip/femur fracture or trauma procedures.

### Key Features

- ▶ Incision film
- ▶ Transparent drape
- ▶ Fluid collection pouch
- ▶ Absorbent patch
- ▶ Tube holders
- ▶ Suction/diathermy pouches
- ▶ Main drape complies to EN 13795-1 High performance critical product area requirements

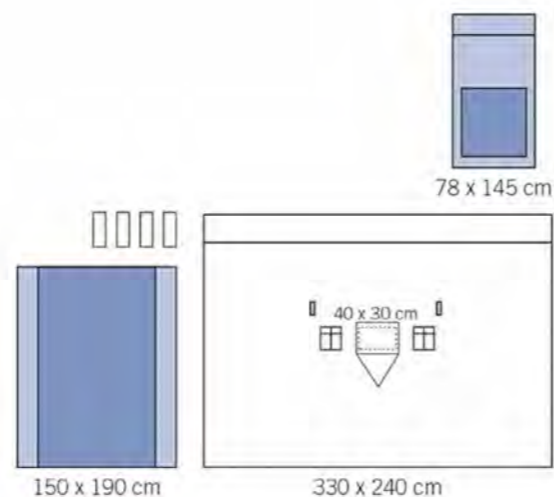

REF	DESCRIPTION	SIZE	Pack Count dispenser/carton
1225-02	Vertical drape set, small, sterile	See Material table	7 / 14

Sales Unit: Transport Carton

### Material

Product Part	Raw Material & Characteristics
4 Hand towels	30 x 34 cm, Pulp, natural white, thread reinforced
1 Mayo cover	78 x 145 cm, reinforced, Laminate: blue PP nonwoven/blue-white PE film/blue PE film
1 Vertical drape, small	240 x 330 cm transparent polyethylene film, incision film 40 x 30 cm: adhesive coated polyethylene film, 2 fluid collection and suction/diathermy pouches transparent polyethylene vinyl acetate, fluid collection pouch wire metal with blue polyethylene coating, bottom outlet white polypropylene, tube holders
1 Instrument table cover	150 x 190 cm, Laminate: PP nonwoven/PE film laminate, blue

## evercare® Vertical drape set Large

REF: 1226-02

evercare® Vertical drape set Large, sterile is a surgical draping set that provides a vertical barrier to keep the C-arm isolated from the sterile surgical field during hip/femur fracture or trauma procedures.

### Key Features

- ▶ Incision film
- ▶ Transparent drape
- ▶ Fluid collection pouch
- ▶ Absorbent patch
- ▶ Tube holders
- ▶ Suction/diathermy pouches
- ▶ Main drape complies to EN 13795-1 High performance critical product area requirements

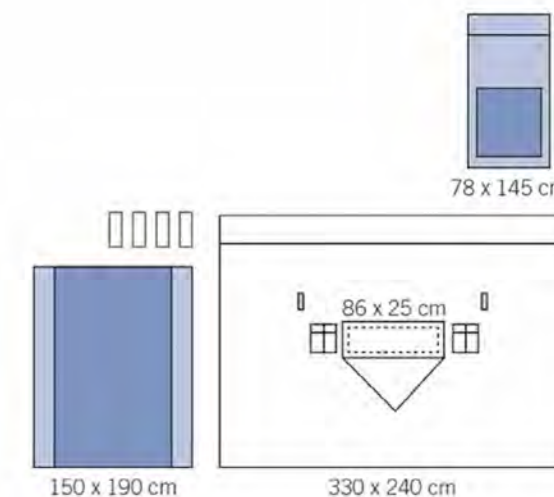

REF	DESCRIPTION	SIZE	Pack Count dispenser/carton
1226-02	Vertical drape set Large, sterile	See Material table	7 / 14

Sales Unit: Transport Carton

### Material

Product Part	Raw Material & Characteristics
4 Hand towels	30 x 34 cm, Pulp, natural white, thread reinforced
1 Mayo cover	78 x 145 cm, reinforced, Laminate: blue PP nonwoven/blue-white PE film/blue PE film
1 Vertical drape large	240 x 330 cm, transparent polyethylene film, incision film 86 x 25 cm, adhesive coated polyethylene film, fluid collection and suction/diathermy pouches 24 x 24 cm, transparent polyethylene vinyl acetate, fluid collection pouch wire metal with blue polyethylene coating, bottom outlet white polypropylene, tube holders blue polyethylene film
1 Universal cover drape	150 x 190 cm, Laminate: PP nonwoven/PE film laminate, blue



## evercare® Extremity set

REF: 1230-02

evercare® Extremity set, sterile is a sterile draping set for knee operations.

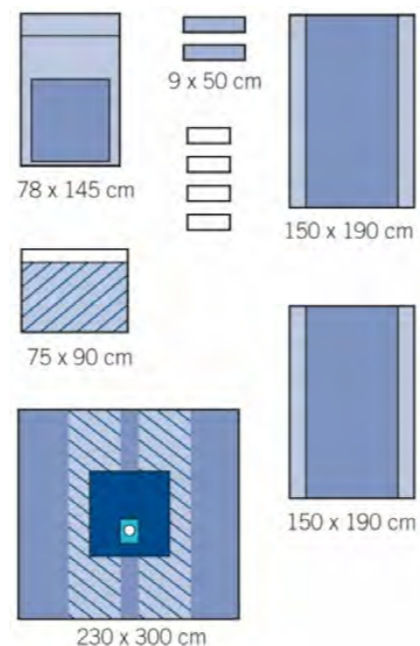

### Key Features

- ▶ Elastic fenestration
- ▶ Absorbent patch
- ▶ Tube holders
- ▶ Adhesive OP Tapes
- ▶ Main drape complies to EN 13795-1 High performance critical product area requirements

REF	DESCRIPTION	SIZE	Pack Count dispenser/carton
1230-02	Extremity set, sterile	See Material table	4 / 8

Sales Unit: Transport Carton

### Material

Product Part	Raw Material & Characteristics
4 Hand towels	30 x 34 cm, Pulp, natural white, thread reinforced
1 Mayo cover	78 x 145 cm, reinforced, Laminate: PP nonwoven/PE-film/PE-film, blue
2 Adhesive Op-tapes	9 x 50 cm, Nonwoven polyester, blue, adhesive coated
1 Instrument table cover, folded	150 x 190 cm, Laminate: PP nonwoven/PE film, blue
1 Adhesive drape sheet	75 x 90 cm, Laminate: blue PP nonwoven/blue PE film/white PP nonwoven
1 Extremity drape	230 x 300 cm Laminate: blue PP nonwoven/blue PE-film/white PP nonwoven blue absorbent patch 50 x 100 cm, PP nonwoven, elastic aperture 7 cm, elastic material SEBS based thermoplastic elastomer, blue, tube holders
1 Instrument table cover	150 x 190 cm, Laminate: PP nonwoven/polyethylene film, blue

## evercare® Extremity set

REF: 1231-02

evercare® Extremity set, sterile is a sterile draping set for knee operations.

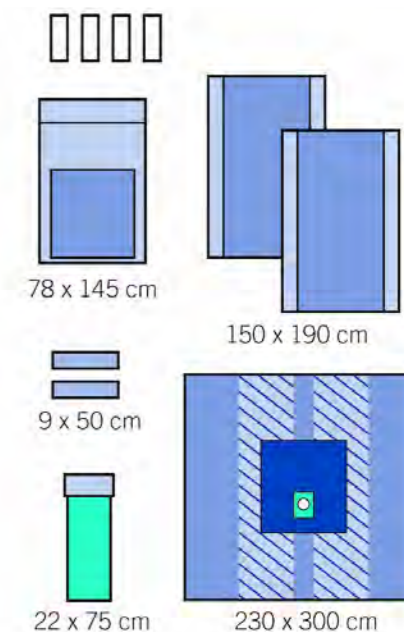

### Key Features

- ▶ Elastic fenestration
- ▶ Absorbent patch
- ▶ Elastic stockinette
- ▶ Tube holders
- ▶ Adhesive OP Tapes
- ▶ Main drape complies to EN 13795-1 High performance critical product area requirements

REF	DESCRIPTION	SIZE	Pack Count dispenser/carton
1231-02	Extremity set, sterile	See Material table	4 / 8

Sales Unit: Transport Carton

### Material

Product Part	Raw Material & Characteristics
4 Hand towels	30 x 34 cm, Pulp, natural white, thread reinforced
1 Mayo cover	78 x 145 cm, reinforced, Laminate: blue PP nonwoven/blue-white PE film/blue PE film, blue absorbent patch 65 x 85 cm
2 Adhesive Op-tapes	9 x 50 cm, Nonwoven polyester, blue, adhesive coated
1 Instrument table cover, folded	150 x 190 cm, PP nonwoven/polyethylene film laminate, blue
1 Stockinette small	22 x 75 cm, Styrene Butadiene Styrene film/elastic gauze polyester, teleskop folding
1 Extremity drape	230 x 300 cm, PP nonwoven/polyethylene film laminate, blue/PP nonwoven, white, blue absorbent patch 50 x 100 cm, PP nonwoven, elastic aperture 7 cm, elastic material styrene/butadiene/styrene, tube holders in blue nonwoven
1 Instrument table cover	150 x 190 cm, PP nonwoven/polyethylene film laminate, blue

## evercare<sup>®</sup> Extremity set

REF: 1231-100

evercare<sup>®</sup> Extremity set, sterile is a sterile draping set for extremity operations.

### Key Features

- ▶ Elastic fenestration
- ▶ Absorbent patch
- ▶ Stockinette
- ▶ Tube holders
- ▶ Adhesive OP Tapes
- ▶ Main drape complies to EN 13795-1 High performance critical product area requirements

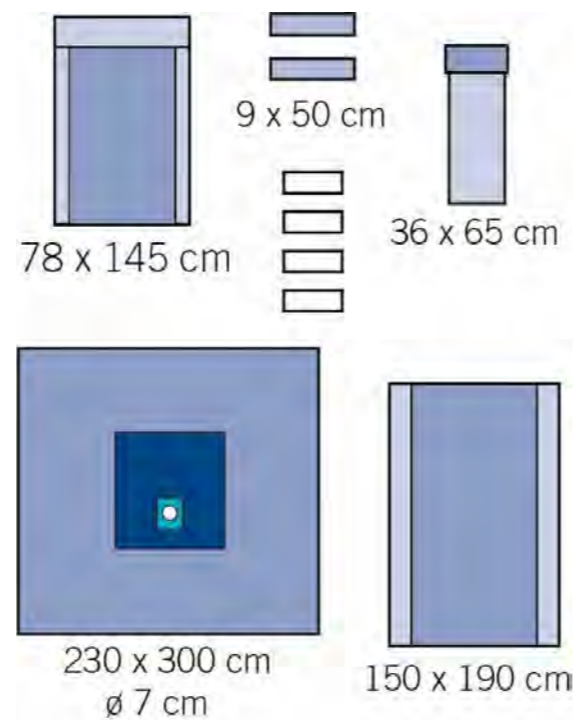

REF	DESCRIPTION	SIZE	Pack Count dispenser/carton
1231-100	Extremity set, sterile	See Material table	6 / 12

Sales Unit: Transport Carton

### Material

Product Part	Raw Material & Characteristics
1 Mayo cover	78 x 145 cm, reinforced, Laminate: PP nonwoven/PE-film/PE-film, blue, absorbent patch 65 x 85 cm
2 Adhesive Op-tape	9 x 50 cm, Nonwoven polyester, blue, adhesive coated
4 Hand towels	30 x 34 cm, Pulp, natural white, thread reinforced
1 Stockinette	36 x 65 cm, Laminate: blue PP nonwoven/blue PE-film
1 Extremity drape	230 x 300 cm, Laminate: blue PP nonwoven /blue PE-film, blue absorbent patch 50 x 100 cm, PP nonwoven, aperture 7 cm, elastic material styrene/butadiene/styrene, tube holders in blue nonwoven
1 Instrument table cover	150 x 190 cm, Laminate: PP nonwoven/polyethylene film laminate, blue

## evercare<sup>®</sup> Extremity drape 230 x 300 cm, aperture 7 cm

REF: 1325-01

evercare<sup>®</sup> Extremity drape, sterile with extra absorbent patch, tube holders and elastic aperture for procedures in knees and feet.

### Key Features

- ▶ Absorbent patch
- ▶ Tube holders
- ▶ Elastic aperture
- ▶ Complies to EN 13795-1 High performance critical product area requirements

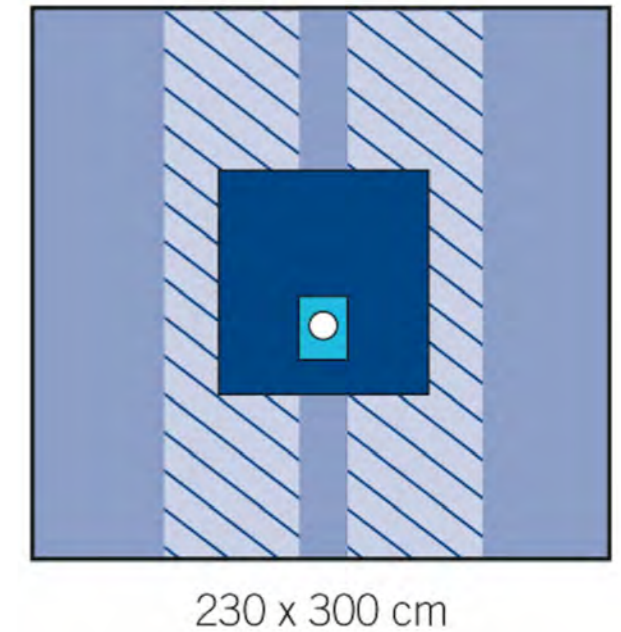

REF	DESCRIPTION	SIZE	Pack Count dispenser/carton
1325-01	Extremity drape, sterile, Blue	230 x 300 cm, elastic Ø 7 cm	8 / 16

Sales Unit: Transport Carton

## evercare<sup>®</sup> Hand/foot set

REF: 1232-02

evercare<sup>®</sup> Hand/foot set, sterile is a draping set for hand/foot operations.

### Key Features

- ▶ Elastic fenestration
- ▶ Absorbent patch
- ▶ Tube holders
- ▶ Main drape complies to EN 13795-1 High performance critical product area requirements

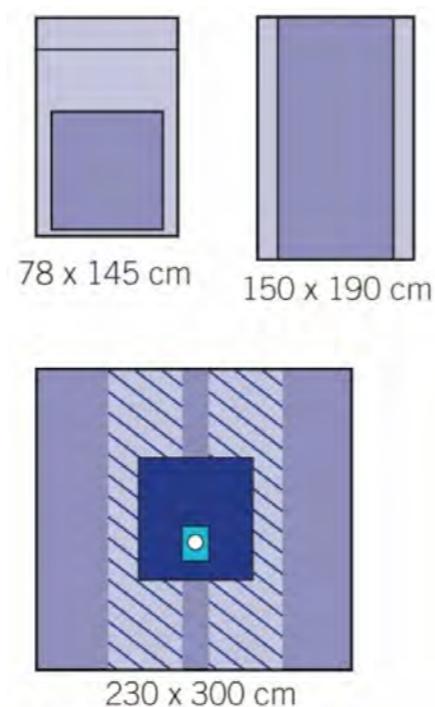

REF	DESCRIPTION	SIZE	Pack Count dispenser/carton
1232-02	Hand/foot set, sterile	See Material table	6 / 12

Sales Unit: Transport Carton

### Material

Product Part	Raw Material & Characteristics
1 Mayo cover	78 x 145 cm, reinforced, Laminate: PP nonwoven/PE-film/PE-film, blue, absorbent patch 65 x 85 cm
1 Hand/foot drape	230 x 300 cm, Laminate: blue PP nonwoven /blue PE-film/PP nonwoven, white, blue absorbent patch 50 x 100 cm, PP nonwoven, elastic aperture 3,5 cm, elastic material SEBS based thermoplastic elastomer, tube holders of blue nonwoven
1 Instrument table cover	150 x 190 cm, Laminate: PP nonwoven/polyethylene film laminate, blue

## evercare<sup>®</sup> Hand/foot set

REF: 1232-50

evercare<sup>®</sup> Hand/foot set, sterile is a draping set for hand/foot operations.

### Key Features

- ▶ Elastic fenestration
- ▶ Absorbent patch
- ▶ Tube holders
- ▶ Adhesive OP Tape
- ▶ Main drape complies to EN 13795-1 High performance critical product area requirements

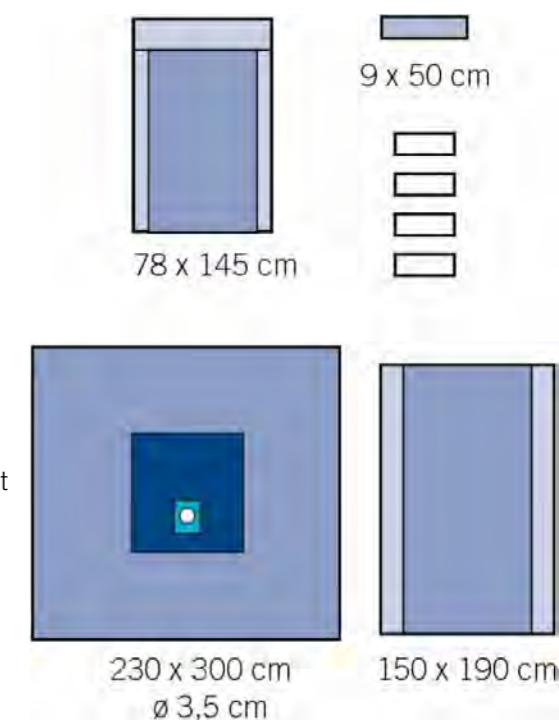

REF	DESCRIPTION	SIZE	Pack Count dispenser/carton
1232-50	Hand/foot set, sterile	See Material table	6 / 12

Sales Unit: Transport Carton

### Material

Product Part	Raw Material & Characteristics
1 Mayo cover	78 x 145 cm, reinforced, Laminate: PP nonwoven/PE-film/PE-film, blue, absorbent patch 65 x 85 cm
1 Adhesive Op-tape	9 x 50 cm, Nonwoven polyester, blue, adhesive coated
4 Hand towel	30 x 34 cm, Pulp, natural white, thread reinforced
1 Hand/foot drape	230 x 300 cm, Laminate: blue PP nonwoven /blue PE-film, blue absorbent patch 75 x 80 cm, PP nonwoven, blue tube holders PP, aperture 3.5 cm, elastic material SEBS based thermoplastic elastomer
1 Instrument table cover	150 x 190 cm, Laminate: PP nonwoven/PE-film, blue

evercare<sup>®</sup> Hand/foot drape 150 x 180 cm, aperture 3,5 cm

REF: 1320-01

evercare<sup>®</sup> Hand/foot drape, sterile with extra absorbent patch, tube holders and elastic aperture for procedures in knees and feet.

### Key Features

- ▶ Absorbent patch
- ▶ Tube holders
- ▶ Elastic aperture
- ▶ Complies to EN 13795-1 High performance critical product area requirements

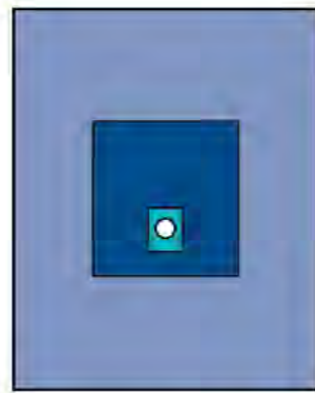

**Size** 150 x 180 cm  
3,5 cm

REF	DESCRIPTION	SIZE	Pack Count dispenser/carton
1320-01	Hand/foot drape, sterile, Blue	150 x 180 cm, elastic Ø 3.5 cm	17 / 34

Sales Unit: Transport Carton

evercare<sup>®</sup> Hand/foot drape 230 x 300 cm, aperture 3,5 cm

REF: 1324-02

evercare<sup>®</sup> Hand/foot drape, sterile with extra absorbent patch, tube holders and elastic aperture for procedures in knees and feet.

### Key Features

- ▶ Absorbent patch
- ▶ Tube holders
- ▶ Elastic aperture
- ▶ Complies to EN 13795-1 High performance critical product area requirements

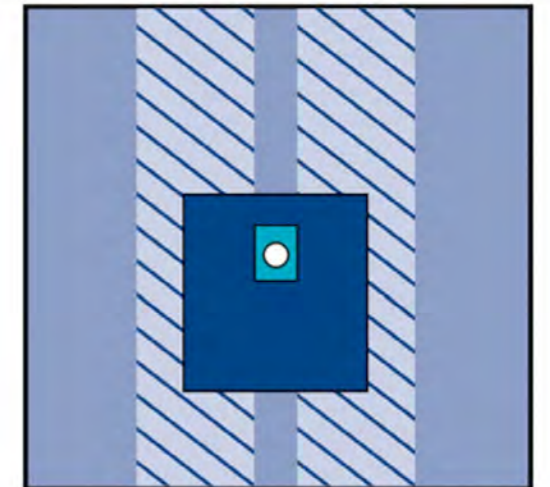

230 x 300 cm

REF	DESCRIPTION	SIZE	Pack Count dispenser/carton
1324-02	Hand/foot drape, sterile, Blue	230 x 300 cm, elastic Ø 3.5 cm	8 / 16

Sales Unit: Transport Carton

## evercare<sup>®</sup> Knee arthroscopy set

REF: 1235-02

evercare<sup>®</sup> Knee arthroscopy set, sterile is a draping set for knee arthroscopies.

### Key Features

- ▶ Elastic fenestration
- ▶ Fluid collection pouch
- ▶ Absorbent patch
- ▶ Elastic stockinette
- ▶ Adhesive OP Tape
- ▶ Main drape complies to EN 13795-1 High performance critical product area requirements

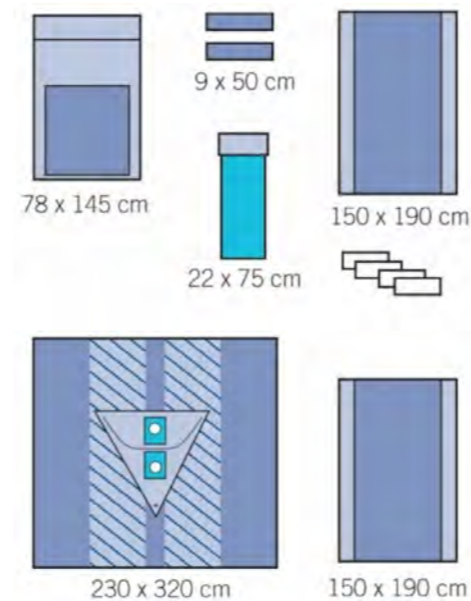

REF	DESCRIPTION	SIZE	Pack Count dispenser/carton
1235-02	Knee arthroscopy set, sterile	See Material table	4 / 8

Sales Unit: Transport Carton

### Material

Product Part	Raw Material & Characteristics
1 Mayo cover	78 x 145 cm, reinforced, Laminate: PP nonwoven/PE-film/PE-film, blue, absorbent patch 65 x 85 cm
4 Hand towels	30 x 34 cm, Pulp, natural white, thread reinforced
2 Adhesive Op-tapes	9 x 50 cm, Nonwoven polyester, blue, adhesive coated
1 Instrument table cover	150 x 190 cm, Laminate: PP nonwoven/polyethylene film, blue
1 Elastic stockinette small	22 x 75 cm, Styrene Butadiene Styrene film/elastic gauze polyester
1 Knee arthroscopy drape	230 x 320 cm, Laminate: PP nonwoven, blue/PE-film blue/PP nonwoven, white elastic material styrene/butadiene/styrene fluid collection pouch transparent polyethylene
1 Instrument table cover	150 x 190 cm, Laminate: PP nonwoven/polyethylene film, blue

## evercare<sup>®</sup> Knee arthroscopy set

REF: 1235-50

evercare<sup>®</sup> Knee arthroscopy set, sterile is a draping set for knee arthroscopies.

### Key Features

- ▶ Elastic fenestration
- ▶ Fluid collection pouch
- ▶ Tube cover with perforated tip
- ▶ Absorbent patch
- ▶ Elastic stockinette
- ▶ Tube holders
- ▶ Adhesive OP Tape
- ▶ Main drape complies to EN 13795-1 High performance critical product area requirements

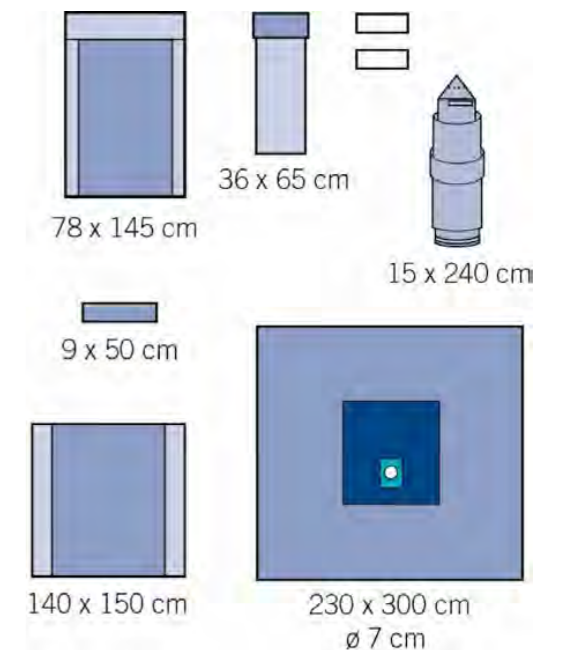

REF	DESCRIPTION	SIZE	Pack Count dispenser/carton
1235-50	Knee arthroscopy set, sterile	See Material table	5 / 10

Sales Unit: Transport Carton

### Material

Product Part	Raw Material & Characteristics
1 Mayo cover	78 x 145 cm, reinforced, Laminate: PP nonwoven/PE-film/PE-film, blue, absorbent patch 65 x 85 cm
1 Tube cover, perforated tip	15 x 240 cm, Polyethylene, transparent
2 Hand towels	30 x 34 cm, Pulp, natural white, thread reinforced
1 Adhesive Op-tape	9 x 50 cm, Nonwoven polyester, blue, adhesive coated
1 Stockinette	36 x 65 cm, Laminate: blue PP nonwoven/blue PE-film
1 Extremity drape	230 x 300 cm, Laminate: blue PP nonwoven /blue PE-film, blue absorbent patch 50 x 100 cm, PP nonwoven, aperture 7 cm, elastic material styrene/butadiene/styrene, tube holders
1 Instrument table cover	140 x 150 cm, Laminate: PP nonwoven/polyethylene film laminate, blue

## evercare<sup>®</sup> Knee arthroscopy drape, 230 x 320 cm

REF: 1328

evercare<sup>®</sup> Knee arthroscopy drape with fluid collection pouch and elastic aperture. Sterile.

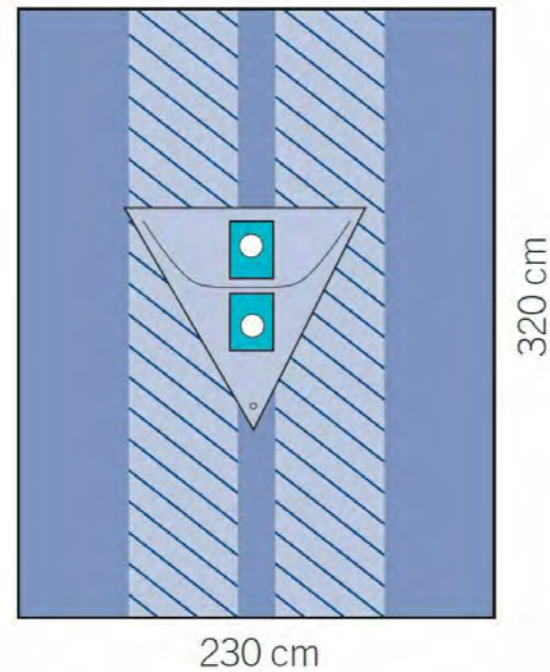

### Key Features

- ▶ Fluid collection pouch
- ▶ Elastic aperture
- ▶ Complies to EN 13795-1 High performance critical product area requirements

REF	DESCRIPTION	SIZE	Pack Count dispenser/carton
1328	Knee arthroscopy drape with fluid collection pouch, sterile, Blue	230 x 320 cm, elastic Ø 5 cm	7 / 14

Sales Unit: Transport Carton

## evercare<sup>®</sup> Shoulder split sheet set with pouch

REF: 1236

evercare<sup>®</sup> Shoulder Split Sheet Set, sterile is a versatile set containing items needed in shoulder operations.

### Key Features

- ▶ Fluid collection pouch
- ▶ Absorbent patch
- ▶ Tube holders
- ▶ Adhesive OP Tape
- ▶ Main drape complies to EN 13795-1 High performance critical product area requirements

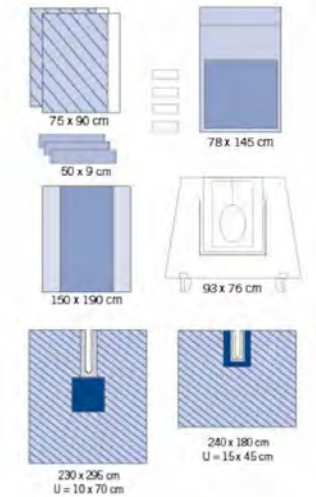

REF	DESCRIPTION	SIZE	Pack Count dispenser/carton
1236	Shoulder Split Sheet Set, sterile	See Material table	2 / 4

Sales Unit: Transport Carton

### Material

Product Part	Raw Material & Characteristics
1 Mayo cover	78 x 145 cm, reinforced, Laminate: blue PP nonwoven/blue-white PE-film/blue PE-film
4 Hand towels	30 x 34 cm, Pulp, natural white, thread reinforced
3 Adhesive OP-tape	9 x 50 cm, Nonwoven polyester, blue, adhesive coated
2 Adhesive drape sheet	75 x 90 cm, Laminate: blue PP nonwoven/blue PE-film/white PP nonwoven
1 Adhesive split sheet,	230 x 295 cm, Laminate: blue PP nonwoven/blue PE-film/white PP nonwoven, blue absorbent patch 90 x 75 cm PP nonwoven, split 10 x 70 cm,
1 Adhesive split sheet	249 x 180, Laminate: blue PP nonwoven/blue PE-film/white PP nonwoven, blue absorbent patch 75 x 90 cm PP nonwoven, split 15 x 45 cm, tube holders
1 Fluid collection pouch	76 x 93 cm, Transparent PEVA film, blue PE coated iron wires, blue PU foam exit ports PE with cap
1 Instrument table cover	150 x 190 cm, Laminate: blue PP nonwoven/blue PE-film

# evercare® Paediatric drapes & sets

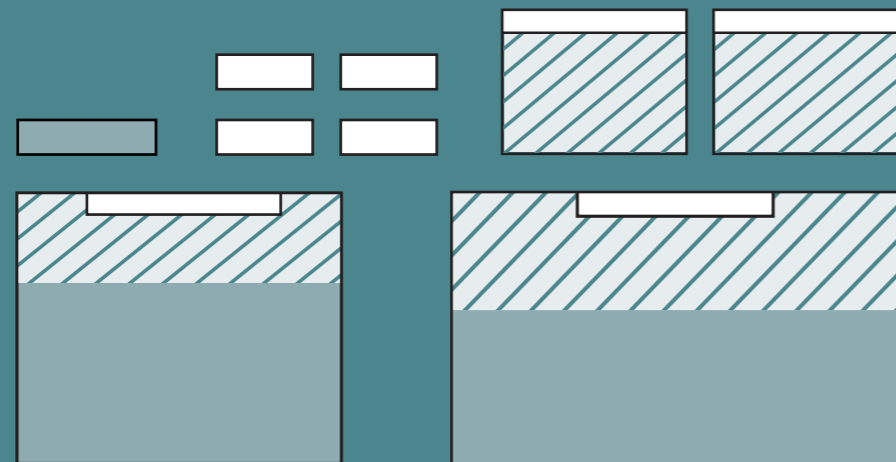

## evercare® Paediatric universal set

REF: 1030-02

evercare® Paediatric universal set, sterile is a versatile set containing items needed in a wide variety of different surgical procedures.

### Key Features

- ▶ Adhesive OP Tape
- ▶ Softer adhesive allows for gentler removal and repositioning of the drape
- ▶ Main drape complies to EN 13795-1 High performance critical product area requirements

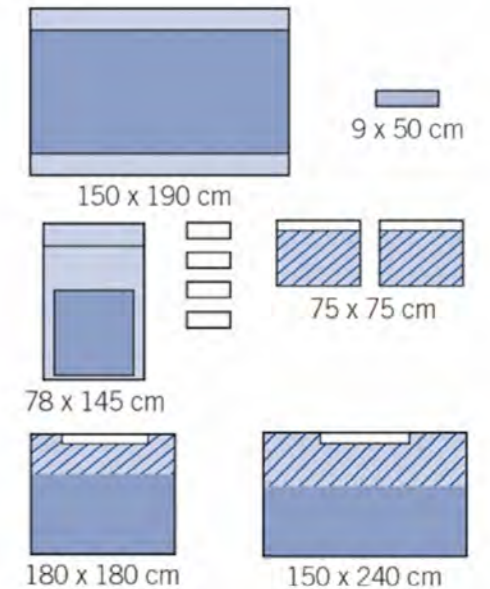

REF	DESCRIPTION	SIZE	Pack Count dispenser/carton
1030-02	Paediatric universal set, sterile	See Material table	7 / 14

Sales Unit: Transport Carton

### Material

Product Part	Raw Material & Characteristics
1 Adhesive Op-tape	9 x 50 cm, Nonwoven polyester, blue, adhesive coated
1 Mayo cover	78 x 145 cm, reinforced, Laminate: PP nonwoven/PE-film/PE-film, blue
4 Hand towels	30 x 34 cm, Pulp, natural white, thread reinforced
2 Adhesive drape sheet, paediatric	75 x 75 cm, Laminate: blue PP nonwoven/blue PE-film/white PP nonwoven
1 Adhesive drape, medium, paediatric	180 x 180 cm, Laminate: blue PP nonwoven/blue PE-film/white PP nonwoven
1 Adhesive drape, large, paediatric	150 x 240 cm, Laminate: blue PP nonwoven/blue PE-film/white PP nonwoven
1 Instrument table cover	150 x 190 cm, Laminate: PP nonwoven/polyethylene film, blue

## evercare® Paediatric absorbent drape, 70 x 60 cm

REF: 1463-50

evercare® Paediatric adhesive absorbent drape, sterile is a versatile, impervious, extra absorbent drape. It is especially designed for patients with sensitive skin as the adhesive edge is only 2,5 cm wide and the adhesive more gentle to the skin. The fabric is also thinner, yet highly absorbent, and conforms nicely to the body contours. Patients that can especially contribute positively from this features are elderly or neonatal.



70 x 60 cm

### Key Features

- ▶ Extra absorbent
- ▶ Softer adhesive allows for gentler removal and repositioning of the drape
- ▶ Complies to EN 13795-1 High performance less critical product area requirements

REF	DESCRIPTION	SIZE	Pack Count dispenser/carton
1463-50	Paediatric adhesive absorbent drape, sterile, Blue	60 x 70 cm, Adhesive edge 2.5 cm	40 / 160

Sales Unit: Transport Carton

## evercare® Paediatric adhesive aperture drape, 35 x 65 cm, variable aperture

REF: 1511

evercare® Paediatric adhesive aperture drape, variable, sterile with integrated edge fixation provides easy and quick draping for a variety of procedures. It is especially designed for patients with sensitive skin as the adhesive edge is significantly smaller and the adhesive more gentle to the skin. Patients that can especially contribute positively from this features are elderly or neonatal.

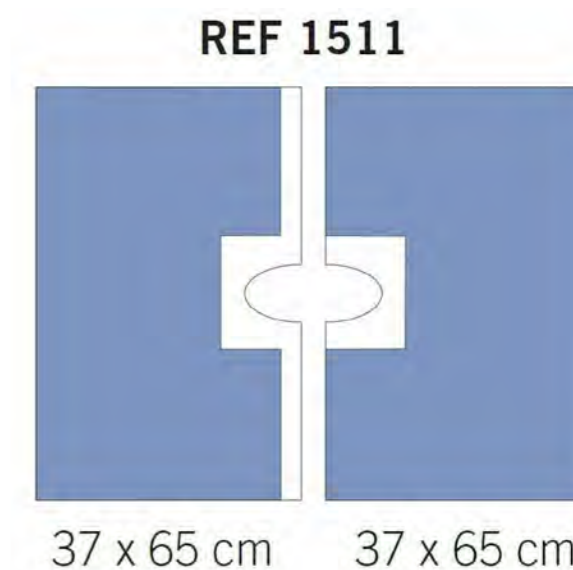

### Key Features

- ▶ Easy and quick draping
- ▶ Softer adhesive allows for gentler removal and repositioning of the drape
- ▶ Complies to EN 13795-1 High performance critical product area requirements

REF	DESCRIPTION	SIZE	Pack Count dispenser/carton
1511	Paediatric adhesive aperture drape, variable, sterile, Blue	37 x 65 cm, adhesive edge 2.5 cm	25 / 100

Sales Unit: Transport Carton



# evercare® Speciality drapes & sets

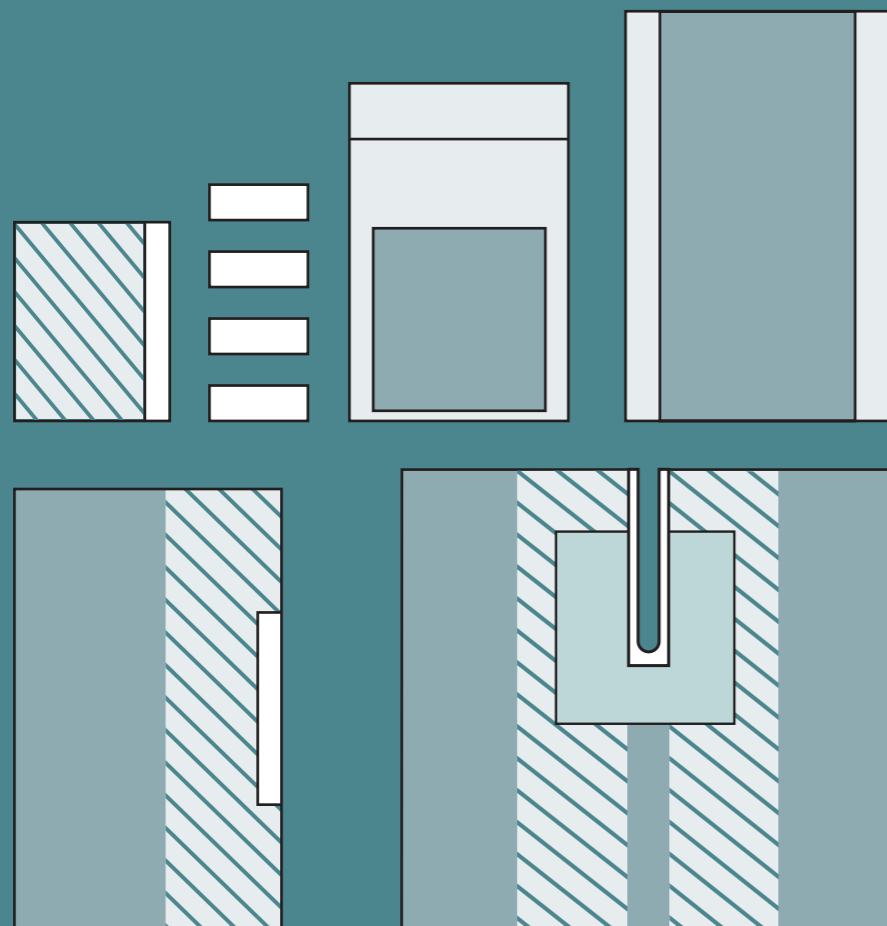

## evercare® Split sheet set

REF: 1050-02

evercare® Split sheet set, sterile is a versatile set containing items needed in a wide variety of different surgical procedures.

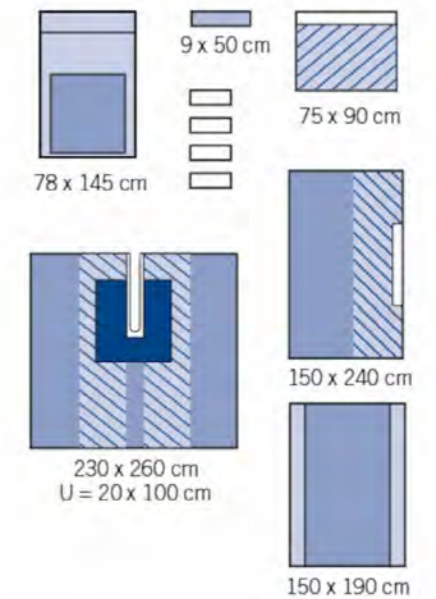

### Key Features

- ▶ Absorbent patch
- ▶ Tube holders
- ▶ Adhesive OP Tape
- ▶ Main drape complies to EN 13795-1 High performance critical product area requirements

REF	DESCRIPTION	SIZE	Pack Count dispenser/carton
1050-02	Split sheet set, sterile	See Material table	4 / 8

Sales Unit: Transport Carton

### Material

Product Part	Raw Material & Characteristics
<b>1 Mayo cover</b>	78 x 145 cm, reinforced, Laminate: blue PP nonwoven/blue-white PE-film/blue PE-film, blue absorbent patch 65 x 85 cm
<b>4 Hand towels</b>	30 x 34 cm, Pulp, natural white, thread reinforced
<b>1 Adhesive Op-tape</b>	9 x 50 cm, Nonwoven polyester, blue, adhesive coated
<b>1 Adhesive drape sheet</b>	75 x 90 cm, Laminate: blue PP nonwoven/blue PE-film/white PP nonwoven
<b>1 Adhesive split sheets</b>	230 x 260 cm, Laminate: blue PP nonwoven/blue PE-film/white PP nonwoven, blue absorbent patch 140 x 75 cm, PP nonwoven, split 20 x 100 cm, Tube holders in nonwoven
<b>1 Adhesive drape large</b>	150 x 240 cm, Laminate: blue PP nonwoven/blue PE-film/white PP nonwoven
<b>1 Instrument table cover</b>	150 x 190 cm, Laminate: blue PP nonwoven/blue PE-film

## evercare® Split sheet set

REF: 1051-02

evercare® Split sheet set, sterile is a versatile set containing items needed in a wide variety of different surgical procedures.

### Key Features

- ▶ Absorbent patch
- ▶ Tube holders
- ▶ Adhesive OP Tape
- ▶ Main drape complies to EN 13795-1 High performance critical product area requirements

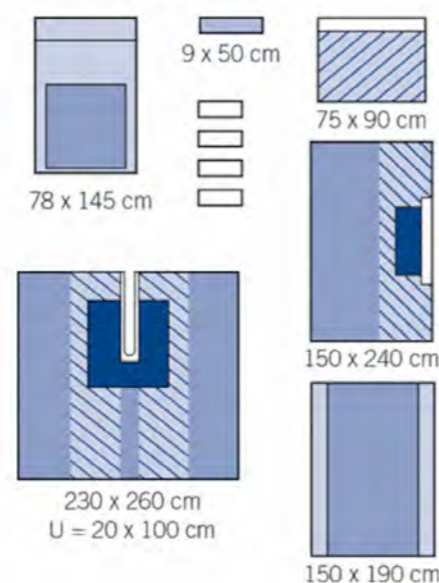

REF	DESCRIPTION	SIZE	Pack Count dispenser/carton
1051-02	Split sheet set, sterile	See Material table	4 / 8

Sales Unit: Transport Carton

### Material

Product Part	Raw Material & Characteristics
1 Mayo cover	78 x 145 cm, reinforced, Laminate: blue PP nonwoven/blue-white PE-film/blue PE-film, blue absorbent patch 65 x 85 cm
4 Hand towels	30 x 34 cm, Pulp, natural white, thread reinforced
1 Adhesive OP-tape	9 x 50 cm, Nonwoven polyester, blue, adhesive coated
1 Adhesive drape sheet	75 x 90 cm, Laminate: blue PP nonwoven/blue PE-film/white PP nonwoven
1 Adhesive split sheets	230 x 260 cm, Laminate: blue PP nonwoven/blue PE-film/white PP nonwoven, blue absorbent patch 140 x 75 cm, PP nonwoven, split 20 x 100 cm sheet folded so that the bottom of the split is visible, tube holders
1 Adhesive drape large	150 x 240 cm, Laminate: blue PP nonwoven/blue PE-film/white PP nonwoven, blue absorbent patch 25 x 60 cm, PP nonwoven
1 Instrument table cover	150 x 190 cm, Laminate: blue PP nonwoven/blue PE-film

## evercare® Abdominal-perineal set

REF: 1248-50

evercare® Abdominal-perineal set, sterile is a draping set for abdominal/perineal operations.

### Key Features

- ▶ Fluid collection pouch
- ▶ Absorbent patch
- ▶ Adhesive OP Tape
- ▶ Main drape complies to EN 13795-1 High performance critical product area requirements

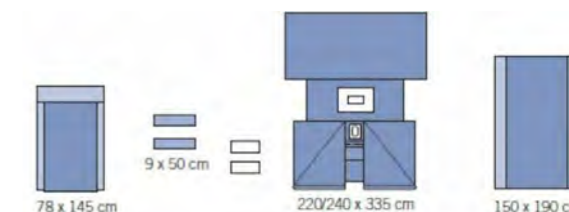

REF	DESCRIPTION	SIZE	Pack Count dispenser/carton
1248-50	Abdominal-perineal set, sterile	See Material table	5 / 10

Sales Unit: Transport Carton

### Material

Product Part	Raw Material & Characteristics
1 Mayo cover	78 x 145 cm, reinforced, Laminate: PP nonwoven/PE-film/PE-film, blue, absorbent patch 65 x 85 cm
2 Hand towels	30 x 34 cm, Pulp, natural white, thread reinforced
2 Adhesive Op-tape	9 x 50 cm, Nonwoven polyester, blue, adhesive coated
1 Gyn-abdominal drape	220/240 x 335 cm, all-in-one with integrated leggings and fluid collection pouch, with 2 Adhesive apertures: top aperture 25 x 30 cm, bottom aperture 9 x 15 cm (with integrated lid-drape to cover the aperture when not needed) . Top and bottom parts blue SMS, middle part laminate blue PP nonwoven/blue PE-film, absorbent reinforcement 50 x 70 cm laminate blue PP nonwoven/blue PE-film, fluid collection pouch transparent PE with blue PE coated aluminium support wire, cover drape laminate blue PP nonwoven/blue PE film
1 Instrument table cover	150 x 190 cm, Laminate: PP nonwoven/polyethylene film laminate, blue

## evercare® Lower vascular drape 230 x 260 cm, split 20 x 100 cm, integrated genital cover

REF: 1317-01

evercare® Lower vascular split sheet with integrated genital cover for easy draping of lower body for vascular surgery. Sterile.

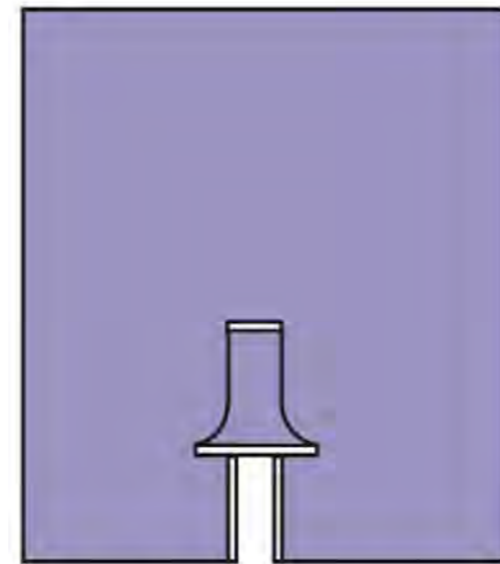

230 x 260 cm  
U = 20 x 100 cm

### Key Features

- ▶ Easy-to-use draping
- ▶ Integrated genital cover
- ▶ Complies to EN 13795-1 High performance critical product area requirements

REF	DESCRIPTION	SIZE	Pack Count dispenser/carton
1317-01	Lower vascular drape, integrated genital cover, sterile, Blue	230 x 260 cm	12 / 24

Sales Unit: Transport Carton

## evercare® Perineal drape

REF: 1356-01

evercare® Perineal drape, sterile is an easy and quick draping of the perineal area. Under the buttocks utility drape 75 x 90 cm to facilitate aseptic draping technique and 75 x 120 cm aperture drape to drape the perineal area.

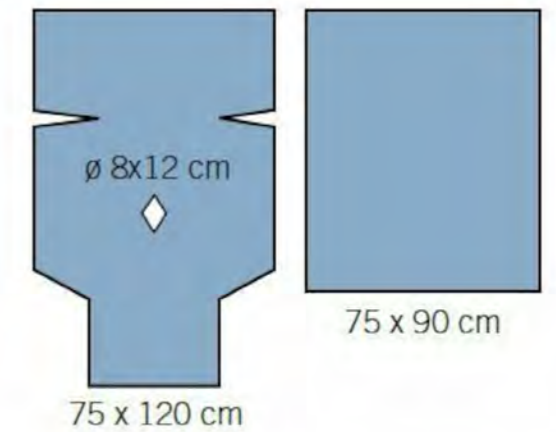

### Key Features

- ▶ Easy and quick draping
- ▶ Complies to EN 13795-1 High performance critical product area requirements

REF	DESCRIPTION	SIZE	Pack Count dispenser/carton
1356-01	Aperture drape with splits and adhesive tapes at edges and utility drape, Blue	Aperture drape 75 x 120 cm, Aperture 8 x 12 cm, Utility drape 75 x 90 cm	17 / 68

Sales Unit: Transport Carton

## evercare<sup>®</sup> Thoracic drape 200/300 x 330 cm, aperture 32 x 40 cm

REF: 1375-01

evercare<sup>®</sup> Thoracic drape, sterile is a tear-resistant and fluid-proof thoracic drape with incision film for cardiovascular procedures. Absorbent patch reinforcement for fluid management. Secure attachment for tubing with tube holders.

### Key Features

- ▶ Incision film
- ▶ Fluid collection pouch
- ▶ Absorbent patch
- ▶ Tube holders
- ▶ Main drape complies to EN 13795-1 High performance critical product area requirements

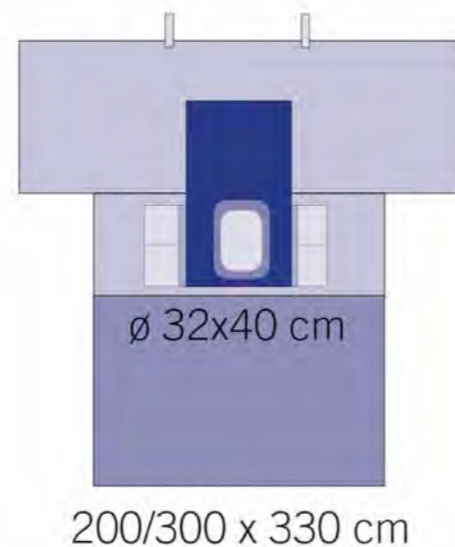

REF	DESCRIPTION	SIZE	Pack Count dispenser/carton
1375-01	Thoracic drape, aperture with incision film, fluid collection pouches, absorbent patch and tube holders, sterile, Blue	200/300 x 330 cm, aperture 32 x 40 cm, absorbent patch 50 x 150 cm	7 / 14

Sales Unit: Transport Carton

## evercare<sup>®</sup> Under buttock drape 75 x 100 cm

REF: 1741-01

evercare<sup>®</sup> Under buttock drape, sterile, with folded top part for easy aseptic draping. The drape is made of soft nonwoven material laminated with fluid-resistant plastic film.

### Key Features

- ▶ For protection and fluid collection
- ▶ Draping for a range of gynecological procedures
- ▶ Reducing the risk for staff's and patient's contact with body fluids
- ▶ Complies to EN 13795-1 High performance critical product area requirements

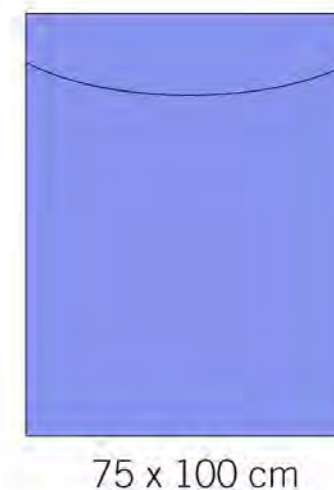

REF	DESCRIPTION	SIZE	Pack Count dispenser/carton
1741-01	Under buttock drape, sterile, Blue	75 x 100 cm	25 / 100

Sales Unit: Transport Carton

# evercare<sup>®</sup> Dislocation bag, 120 x 75 cm

REF: 1878

evercare<sup>®</sup> Dislocation bag, sterile is a rectangular large bag with adhesive edge to be used in hip surgery.

## Key Features

- ▶ Blue
- ▶ Adhesive bag
- ▶ Complies to EN 13795-1 High performance less critical product area requirements



120 x 75 cm

REF	DESCRIPTION	SIZE	Pack Count dispenser/carton
1878	Dislocation bag, sterile, Blue	120 x 75 cm	20 / 80

Sales Unit: Transport Carton



# evercare® Table covers and components

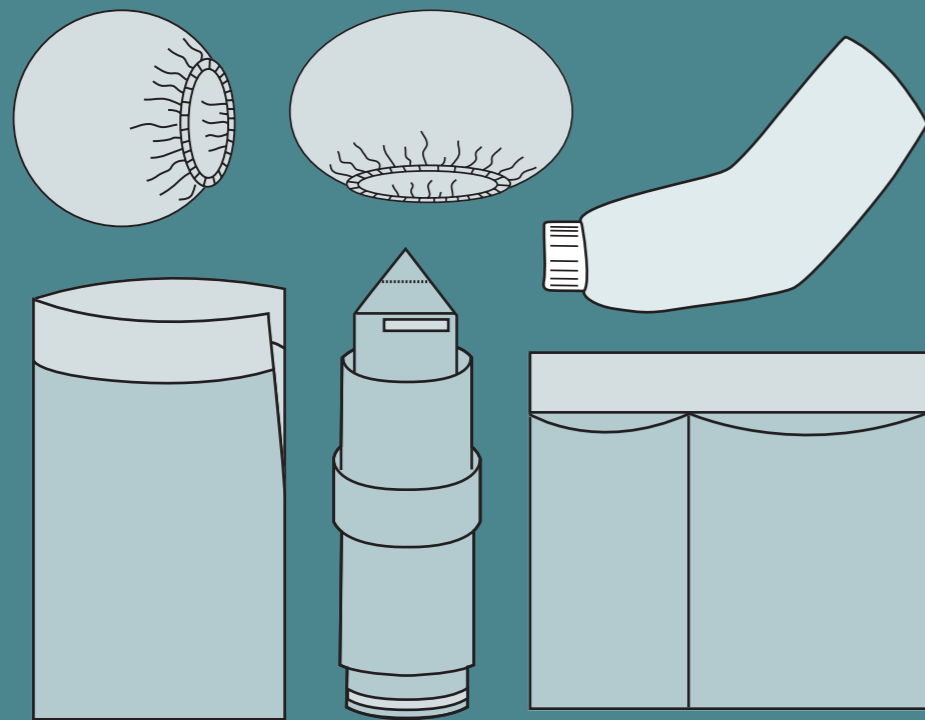

evercare® Leggings, 75 x 120 cm, 2 pcs

REF: 1390-01

evercare® Leggings, sterile is a pair of durable leggings to cover the patients leg in gynaecological, urological etc. procedures.

## Key Features

- ▶ 2-pack
- ▶ Complies to EN 13795-1 High performance critical product area requirements

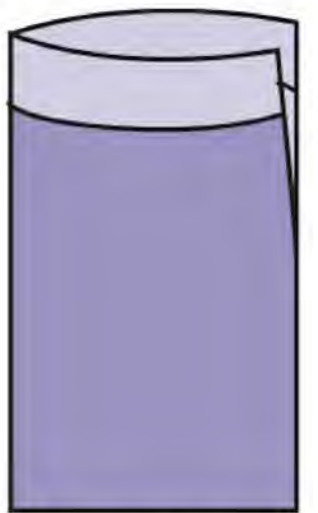

75 x 120 cm  
2 pcs

REF	DESCRIPTION	SIZE	Pack Count dispenser/carton
1390-01	Leggings, 2pcs, sterile, Blue	75 x 120 cm	9 / 36

Sales Unit: Transport Carton

## evercare<sup>®</sup> Genital cover, 20 x 42 cm

REF: 1393-01

evercare<sup>®</sup> Genital cover, sterile is an adhesive patch to cover the genital area before draping of the patient.

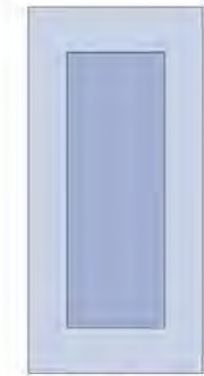

20 x 42 cm

### Key Features

- ▶ Unisex

REF	DESCRIPTION	SIZE	Pack Count dispenser/carton
1393-01	Genital cover with adhesive edges, sterile	20 x 42 cm	55 / 220

Sales Unit: Transport Carton

## evercare<sup>®</sup> Stockinette, large, 30 x 120 cm

REF: 1395-01

evercare<sup>®</sup> Stockinette, sterile is an easy to drape two-layer stockinette to cover limbs before draping, particularly during orthopedic surgery. Outer layer elastic membrane, inner layer soft and comfortable.



30 x 120 cm

### Key Features

- ▶ Easy to drape
- ▶ Inner layer soft and comfortable

REF	DESCRIPTION	SIZE	Pack Count dispenser/carton
1395-01	Stockinette, sterile, Blue	Large, 30 x 120 cm	10 / 40

Sales Unit: Transport Carton

## evercare® Stockinette, small

REF: 1396-01

evercare® Stockinette, sterile is an easy to drape two-layer stockinette to cover limbs before draping, particularly during orthopedic surgery. Outer layer elastic membrane, inner layer soft and comfortable.

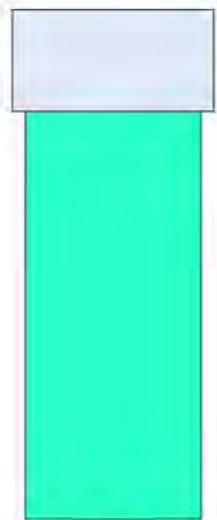

22 x 75 cm

### Key Features

- ▶ Easy to drape
- ▶ Inner layer soft and comfortable

REF	DESCRIPTION	SIZE	Pack Count dispenser/carton
1396-01	Stockinette, sterile, Blue	Small, 22 x 75 cm	20 / 80

Sales Unit: Transport Carton

## evercare® Arm cover

REF: 1398-01

evercare® Arm cover, sterile is a disposable arm cover with high quality cuff.



### Key Features

- ▶ High quality cuff
- ▶ Complies to EN 13795-1 High performance critical product area requirements

REF	DESCRIPTION	SIZE	Pack Count dispenser/carton
1398-01	Arm cover, sterile, Blue	Length 57 cm	30 / 120

Sales Unit: Transport Carton



## evercare<sup>®</sup> Tube holder, 2,5 x 30 cm

REF: 1498-01

evercare<sup>®</sup> Tube holder, sterile is an adhesive tube holder featuring hook and loop for easy fixation of tubing etc. during surgical procedures.

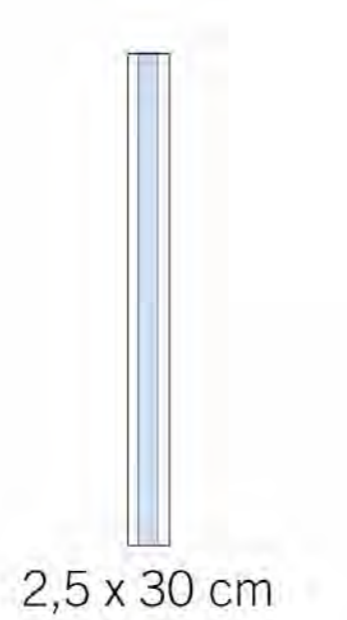

### Key Features

- ▶ Easy fixation of tubing

REF	DESCRIPTION	SIZE	Pack Count dispenser/carton
1498-01	Tube holder, sterile	2,5 x 30 cm	60 / 240

Sales Unit: Transport Carton

## evercare<sup>®</sup> Mayo cover, 79 x 145 cm, reinforced

REF: 1712-01

evercare<sup>®</sup> Mayo cover, reinforced, sterile is a strong, easy-to-drape cover for Mayo stand.

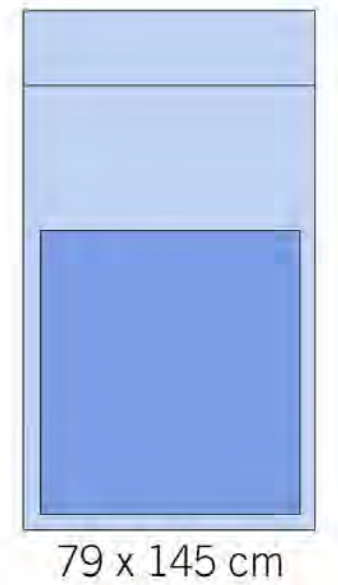

### Key Features

- ▶ Easy to drape cover
- ▶ Reinforced
- ▶ Complies to EN 13795-1 High performance critical product area requirements

REF	DESCRIPTION	SIZE	Pack Count dispenser/carton
1712-01	Mayo cover, reinforced, sterile, Blue	79 x 145 cm	20 / 80

Sales Unit: Transport Carton

## evercare<sup>®</sup> Mayo cover 79 x 145 cm, extra reinforced

REF: 1714-01

evercare<sup>®</sup> Mayo cover, extra reinforced, sterile is a strong, easy-to-drape cover for Mayo stand.

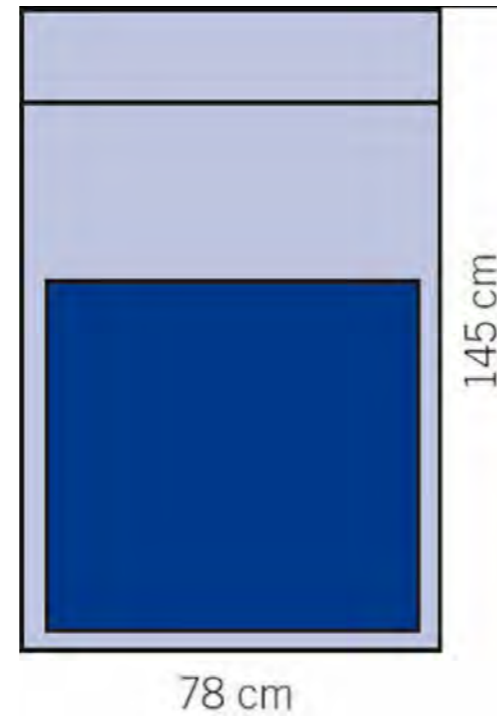

### Key Features

- ▶ Easy to drape cover
- ▶ Extra reinforced
- ▶ Complies to EN 13795-1 High performance critical product area requirements

REF	DESCRIPTION	SIZE	Pack Count dispenser/carton
1714-01	Mayo cover, extra reinforced, sterile, Blue	79 x 145 cm	17 / 68

Sales Unit: Transport Carton

## evercare<sup>®</sup> Seat cover

REF: 1730-01

evercare<sup>®</sup> Seat cover, is a sterile disposable device intended for use as isolation cover for variety of objects in OP-theatre, to prevent contamination transfer.

### Key Features

- ▶ Cover suitable for variety of object shapes
- ▶ Seat surface covering
- ▶ Stay in place thanks to elastic band
- ▶ Soft non-woven material
- ▶ Complies to EN 13795-1 High performance critical product area requirements

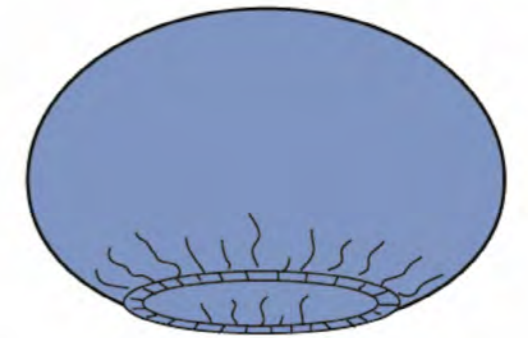

REF	DESCRIPTION	SIZE	PACK COUNT dispenser/carton
1730-01	Seat cover, sterile, Blue	Ø 90 cm	7 / 28

Sales Unit: Transport Carton

## evercare<sup>®</sup> Tube cover

REF: 1810, 1815

evercare<sup>®</sup> Tube cover, sterile is available in a wide range of sterile equipment drapes to suit most applications.

### Key Features

- ▶ Transparent
- ▶ Complies to EN 13795-1 High performance critical product area requirements

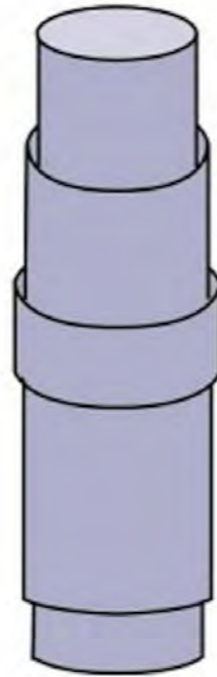

REF	DESCRIPTION	SIZE	Pack Count dispenser/carton
1810	Tube cover, sterile, Transparent	8 x 120 cm	65 / 260
1815	Tube cover, sterile, Transparent	15 x 250 cm	30 / 120

Sales Unit: Transport Carton

## evercare<sup>®</sup> Tube cover, perforated tip, 15 x 240 cm

REF: 1820

evercare<sup>®</sup> Tube cover, sterile is available in a wide range of sterile equipment drapes to suit most applications.

### Key Features

- ▶ Transparent
- ▶ Complies to EN 13795-1 High performance critical product area requirements

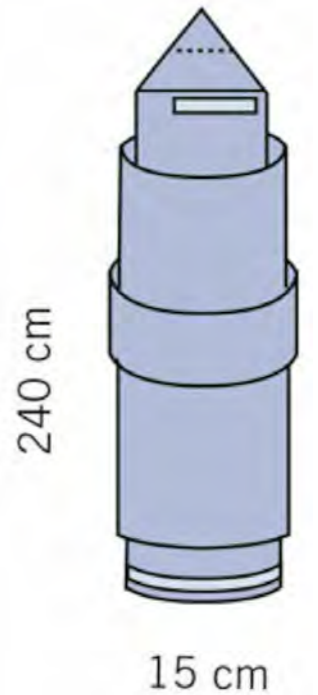

REF	DESCRIPTION	SIZE	Pack Count dispenser/carton
1820	Tube cover, sterile, Transparent	15 x 240 cm	30 / 120

Sales Unit: Transport Carton

## evercare<sup>®</sup> Tube cover, elastic tip, 17 x 240 cm

REF: 1825

evercare<sup>®</sup> Tube cover, elastic tip, sterile is available in a wide range of sterile equipment drapes to suit most applications.

### Key Features

- ▶ Transparent
- ▶ Complies to EN 13795-1 High performance critical product area requirements

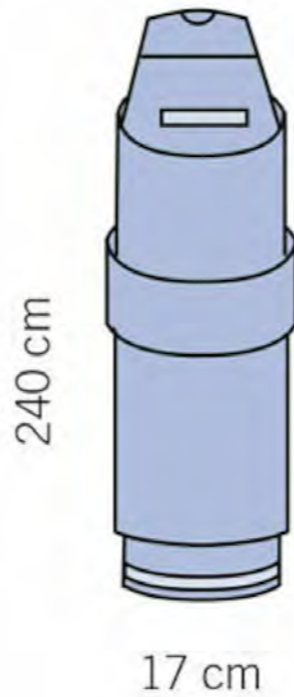

REF	DESCRIPTION	SIZE	Pack Count dispenser/carton
1825	Tube cover, elastic tip, sterile, Transparent	17 x 240 cm	30 / 120

Sales Unit: Transport Carton

## evercare<sup>®</sup> Banded bag

REF: 1850, 1855-01

evercare<sup>®</sup> Banded bag, sterile are circular, disposable bags for covering a variety of equipment for use in the operation room and other hospital departments where sterile equipment draping is needed.

### Key Features

- ▶ Transparent
- ▶ Circular disposable bag
- ▶ Complies to EN 13795-1 High performance critical product area requirements

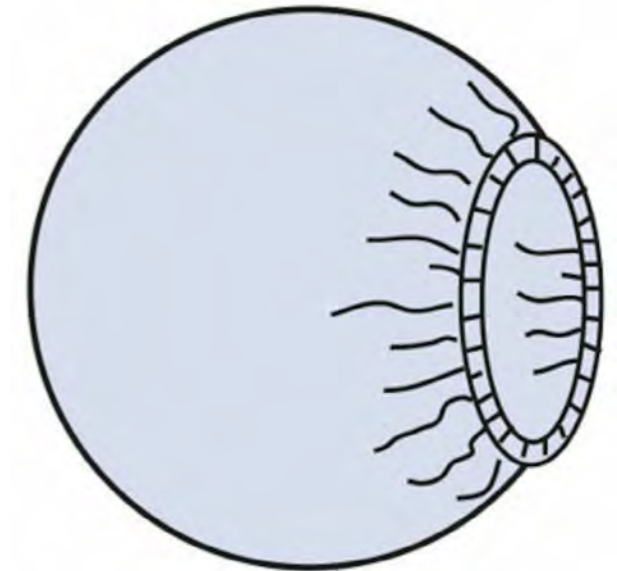

REF	DESCRIPTION	SIZE	Pack Count dispenser/carton
1850	Banded bag, sterile, Transparent	Ø 90 cm	18 / 72
1855-01	Banded bag, sterile, Transparent	Ø 140 cm	10 / 40

Sales Unit: Transport Carton

## evercare<sup>®</sup> Fluid collection pouch, 30 x 40 cm

REF: 1870

evercare<sup>®</sup> Fluid collection pouch, sterile are pouches for collection of substances such as blood, bodily fluids, rinsing fluids, body tissue from operation site etc.

### Key Features

- ▶ Transparent

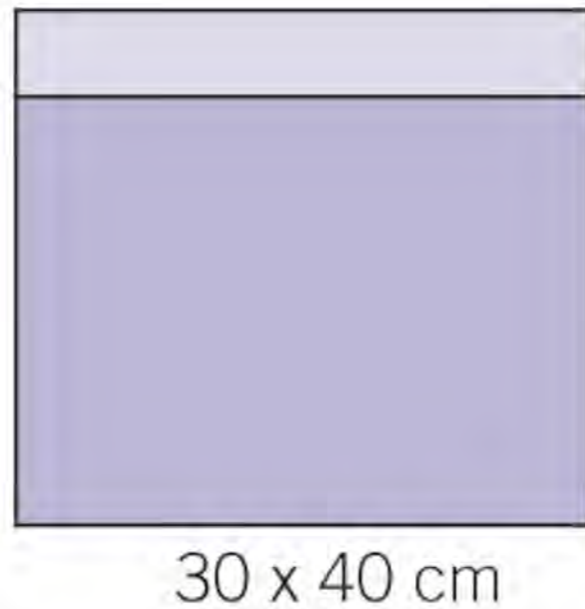

REF	DESCRIPTION	SIZE	Pack Count dispenser/carton
1870	Fluid collection pouch, sterile, Transparent	30 x 40 cm	55 / 220

Sales Unit: Transport Carton

## evercare<sup>®</sup> Fluid collection pouch with sieve, 62 x 50 cm

REF: 1873

evercare<sup>®</sup> Fluid collection pouch with sieve, sterile is a transparent irrigation pouch which contains an adhesive strip, sieve and exit port. Designed to collect irrigation fluids and tissue specimens during surgical procedures.

### Key Features

- ▶ Transparent
- ▶ Adhesive bag

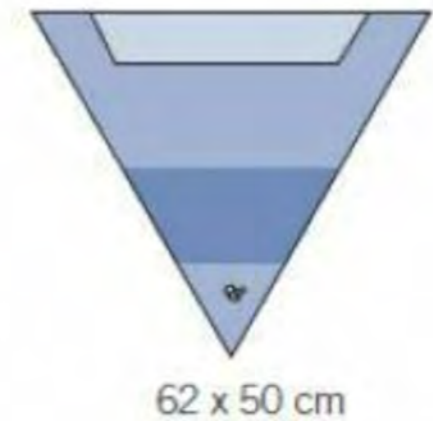

REF	DESCRIPTION	SIZE	Pack Count dispenser/carton
1873	Fluid collection pouch with sieve, sterile, Transparent	62 x 50 cm	11 / 44

Sales Unit: Transport Carton

## evercare<sup>®</sup> Fluid collection pouch, shoulder, 93 x 76 cm

REF: 1876

evercare<sup>®</sup> Fluid Collection pouch, shoulder, sterile is a transparent pouch which contains an adhesive strip. Designed to collect irrigation fluids and tissue specimens during surgical procedures.

### Key Features

- ▶ Shoulder pouch for arthroscopy.
- ▶ 2 drainage ports for efficient fluid handling.
- ▶ Adhesive that can be applied to drapes or patient.
- ▶ Fits and compatible well with special designed split drapes.

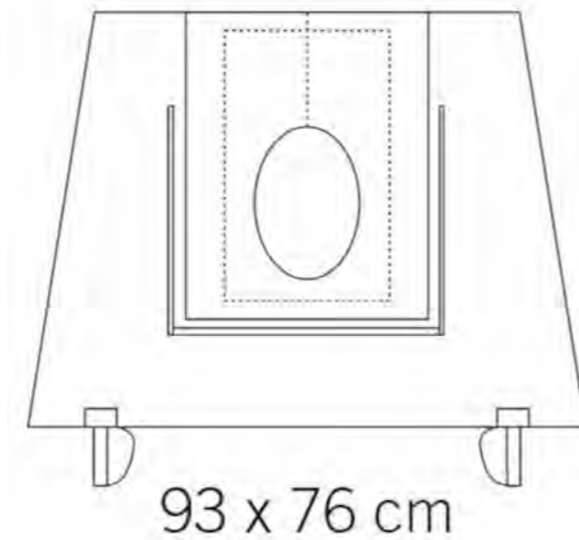

REF	DESCRIPTION	SIZE	Pack Count dispenser/carton
1876	Fluid Collection pouch, shoulder, sterile, Transparent	93 x 76 cm	11 / 44

Sales Unit: Transport Carton

## evercare<sup>®</sup> Suction and diathermy pouch, 30 x 40 cm

REF: 1872

evercare<sup>®</sup> Suction and diathermy pouch, sterile is a transparent adhesive bag used as holder for suction and diathermy equipment.

### Key Features

- ▶ Transparent
- ▶ Adhesive bag

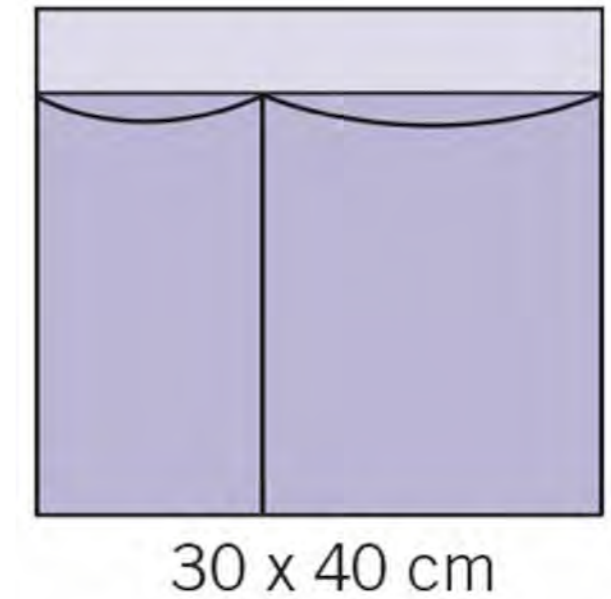

REF	DESCRIPTION	SIZE	Pack Count dispenser/carton
1872	Suction and diathermy pouch, sterile, Transparent	30 x 40 cm	55 / 220

Sales Unit: Transport Carton

# evercare® Universal drapes & sets



## evercare® Universal set with Mayo stand cover, 2-layer, 15x50 cm abs. patches

REF: 1006-01

evercare® Universal set, sterile is a versatile set containing patient and table drapes needed in a wide variety of different surgical procedures. The component in size 150 x 240 cm designed with adhesive tape with cut peel-papers in shorter length to ease the draping and allow sequenced covering.

### Key Features

- ▶ Absorbent patch
- ▶ Tube holders
- ▶ Adhesive OP Tape
- ▶ Main drape complies to EN 13795-1 High performance critical product area requirements

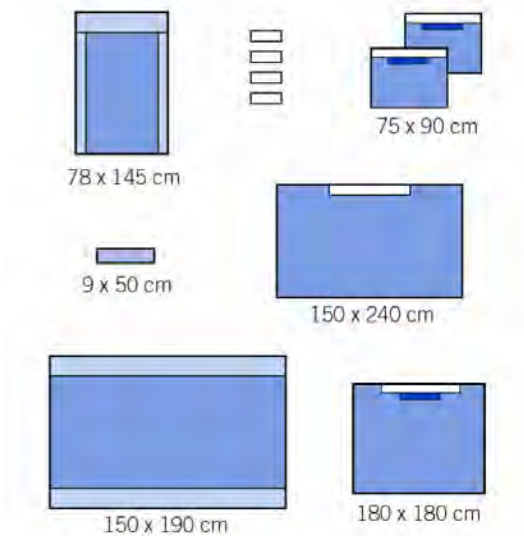

REF	DESCRIPTION	SIZE	Pack Count dispenser/carton
1006-01	Universal set, sterile	See Material table	6 / 12

### Material

Product Part	Raw Material & Characteristics
<b>1 Mayo cover</b>	78 x 145 cm, reinforced, Laminate: blue PP nonwoven/blue-white PE film/blue PE film, blue absorbent patch 65 x 85 cm
<b>1 Adhesive Op-tape</b>	9 x 50 cm, Nonwoven, polyester, blue, adhesive coated
<b>4 Hand towels</b>	30 x 34 cm, Pulp, natural white, thread reinforced
<b>2 Adhesive drape sheets</b>	75 x 90 cm, Laminate: blue PP nonwoven/blue PE-film, blue absorbent patch 15 x 50 cm, PP nonwoven
<b>1 Adhesive drape medium</b>	180 x 180 cm Laminate: blue PP nonwoven/blue PE-film, blue absorbent patch 15 x 50 cm, PP nonwoven, Tube holders in nonwoven
<b>1 Adhesive drape large</b>	150 x 240 cm, Laminate: blue PP nonwoven/blue PE-film
<b>1 Instrument table cover</b>	150 x 190 cm, Laminate: PP nonwoven/PE film, blue

## evercare® Universal Set

REF: 1001

evercare® Universal Set, sterile is a versatile set containing patient and table drapes needed in a wide variety of different surgical procedures.

### Key Features

- ▶ Absorbent patch
- ▶ Tube holders
- ▶ Adhesive OP Tape
- ▶ Softer adhesive allows for gentler removal and repositioning of the drape
- ▶ Main drape complies to EN 13795-1 High performance critical product area requirements

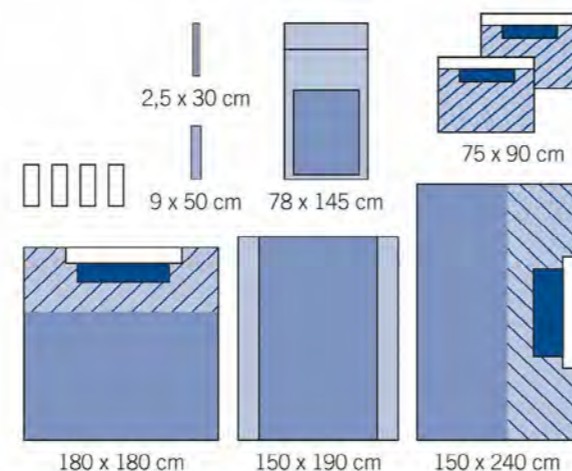

REF	DESCRIPTION	SIZE	Pack Count dispenser/carton
1001	Universal Set, sterile	See Material table	5 / 10

Sales Unit: Transport Carton

### Material

Product Part	Raw Material & Characteristics
1 Adhesive OP-tape	9 x 50 cm, Nonwoven polyester, blue, adhesive coated
1 Mayo cover	78 x 145 cm, reinforced, Laminate: blue PP nonwoven/blue-white PE film/blue PE film
4 Hand towels	30 x 34 cm, Pulp, natural white, thread reinforced
1 Tube holder (hook and loop)	2,5 x 30 cm, Polyamide/Polyurethane
2 Adhesive drape sheet	75 x 90 cm, Laminate: blue PP nonwoven/blue PE-film/white PP nonwoven, blue absorbent patch 25 x 60 cm PP nonwoven
1 Adhesive drape, medium	180 x 180 cm, Laminate: blue PP nonwoven/blue PE-film/white PP nonwoven, blue absorbent patch PP nonwoven 25 x 60 cm
1 Adhesive drape, large	150 x 240 cm, Laminate: blue PP nonwoven/blue PE-film/white PP nonwoven, blue absorbent patch PP nonwoven 25 x 60 cm
1 Instrument table cover	150 x 190 cm, laminate: PP nonwoven/PE film, blue

## evercare® Essentia universal set

REF: 1003

evercare® Essentia universal set, sterile is a basic universal set for non-invasive surgery designed for cost efficiency. Material that ensures mini-mal particle release (low linting), soft and gentle adhesive edges, and absorbent top layer.

### Key Features

- ▶ Absorbent top layer
- ▶ Adhesive OP Tape
- ▶ Softer adhesive allows for gentler removal and repositioning of the drape
- ▶ Main drape complies to EN 13795-1 High performance critical product area requirements

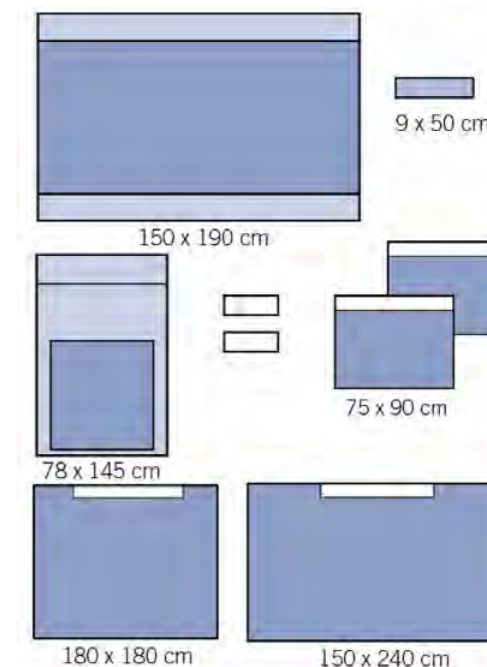

REF	DESCRIPTION	SIZE	Pack Count dispenser/carton
1003	Essentia universal set, sterile	See Material table	6 / 12

Sales Unit: Transport Carton

### Material

Product Part	Raw Material & Characteristics
1 Mayo cover	78 x 145 cm, reinforced, Laminate: blue PP nonwoven/blue-white PE film/blue PE film
2 Hand towels	30 x 34 cm, Pulp, natural white, thread reinforced
1 Adhesive OP-tape	9 x 50 cm, Nonwoven polyester, blue, adhesive coated
2 Adhesive drape	75 x 90 cm, Laminate blue PP nonwoven/blue PE-film
1 Adhesive drape large	150 x 240 cm, Laminate blue PP nonwoven/blue PE-film
1 Adhesive drape, medium	180 x 180 cm, Laminate blue PP nonwoven/blue PE-film
1 Instrument table cover	159 x 190 cm, Laminate PP nonwoven/PE film, blue



## evercare® Universal set with Mayo stand cover, 2-layer, without abs. patches

REF: 1005-02

evercare® Universal set with Mayo stand cover, sterile is a versatile set containing patient and table drapes needed in a wide variety of different surgical procedures. The components in size 150 x 240 cm and 180 x 190 cm are designed with adhesive tape with cut peel-papers in shorter length to ease the draping and allow sequenced covering.

### Key Features

- ▶ Adhesive OP Tape
- ▶ Main drape complies to EN 13795-1 High performance critical product area requirements

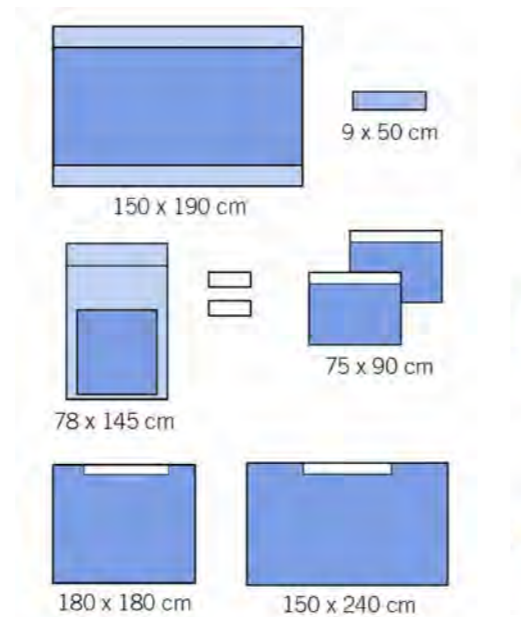

REF	DESCRIPTION	SIZE	Pack Count dispenser/carton
1005-02	Universal set with Mayo stand cover, sterile	See Material table	6 / 12

### Material

Product Part	Raw Material & Characteristics
1 Adhesive Op-tape	9 x 50 cm, Nonwoven, polyester, blue, adhesive coated
1 Mayo cover	78 x 145 cm, reinforced, Laminate: blue PP nonwoven/blue-white PE film/blue PE film, blue absorbent patch 65 x 85 cm
2 Hand towels	30 x 34 cm, Pulp, natural white, thread reinforced
2 Adhesive drape sheets	75 x 90 cm, Laminate: blue PP nonwoven/blue PE-film
1 Adhesive drape medium	180 x 180 cm, Laminate: blue PP nonwoven/blue PE-film
1 Adhesive drape large	150 x 240 cm, Laminate: blue PP nonwoven/blue PE-film
1 Instrument table cover	150 x 190 cm, laminate: PP nonwoven/PE film, blue-grey

## evercare® Universal set with Mayo stand cover, 3-layer, 85 cm tapes

REF: 1010-02

evercare® Universal set with Mayo stand cover, sterile is a versatile set containing items needed in a wide variety of different surgical procedures.

### Key Features

- ▶ Absorbent patch
- ▶ Tube holders
- ▶ Adhesive OP Tape
- ▶ Main drape complies to EN 13795-1 High performance critical product area requirements

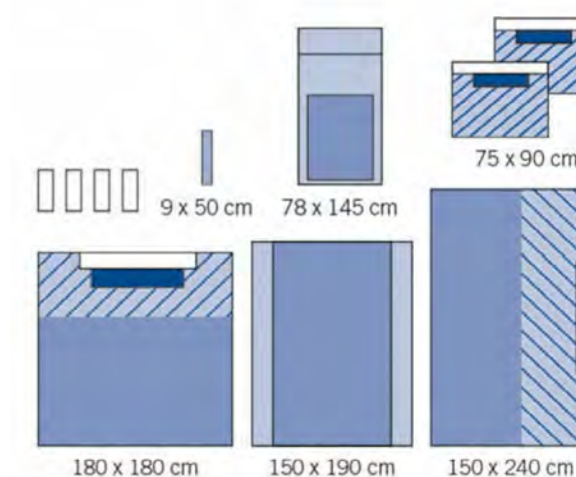

REF	DESCRIPTION	SIZE	Pack Count dispenser/carton
1010-02	Universal set with Mayo stand cover, sterile, Blue	See Material table	5 / 10

### Material

Product Part	Raw Material & Characteristics
1 Adhesive Op-tape	9 x 50 cm, Nonwoven, polyester, blue, adhesive coated
1 Mayo cover	78 x 145 cm, Laminate: blue PP nonwoven/blue-white PE film/blue PE film, blue absorbent patch 65 x 85 cm
4 Hand towels	30 x 34 cm, Pulp, natural white, thread reinforced
2 Adhesive drape sheets	75 x 90 cm, Laminate: blue PP nonwoven/blue PE-film/white PP nonwoven, blue absorbent patch 15 x 50 cm, PP nonwoven
1 Adhesive drape medium	180 x 180 cm, Laminate: blue PP nonwoven/blue PE-film/white PP nonwoven, blue absorbent patch 15 x 50 cm, PP nonwoven, Tube holders
1 Adhesive drape large	150 x 240 cm, Laminate: blue PP nonwoven/blue PE-film/white PP nonwoven
1 Instrument table cover	150 x 190 cm, Laminate: PP nonwoven/PE film, blue

## evercare<sup>®</sup> Universal set with Mayo stand cover, 3-layer, abs. patch 25 x 60 cm

REF: 1011-02

evercare<sup>®</sup> Universal set with Mayo stand cover, sterile containing patient and table drapes needed in a wide variety of different surgical procedures. The component in size 180 x 180 cm and 150 x 240 cm are designed with adhesive tape with cut peel-papers in shorter length to ease the draping and allow sequenced covering.

### Key Features

- ▶ Absorbent patch
- ▶ Tube holders
- ▶ Adhesive OP Tape
- ▶ Main drape complies to EN 13795-1 High performance critical product area requirements

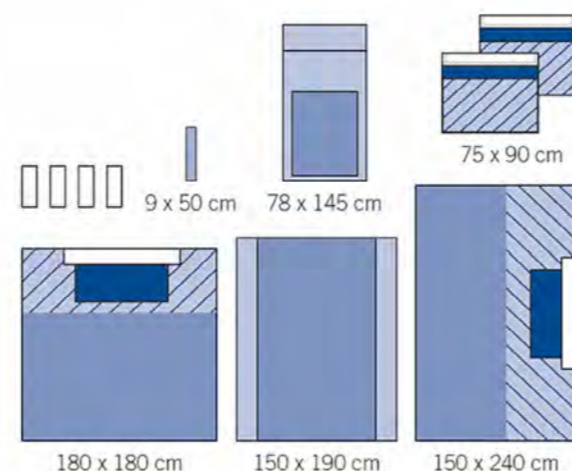

REF	DESCRIPTION	SIZE	Pack Count dispenser/carton
1011-02	Universal set with Mayo stand cover, sterile	See Material table	5 / 10

### Material

Product Part	Raw Material & Characteristics
1 Adhesive Op-tape	9 x 50 cm, Nonwoven, polyester, blue, adhesive coated
1 Mayo cover	78 x 145 cm, reinforced, Laminate: blue PP nonwoven/blue-white PE film/blue PE film, blue absorbent patch 65 x 85 cm
4 Hand towels	30 x 34 cm, Pulp, natural white, thread reinforced
2 Adhesive drape sheets	75 x 90 cm, Laminate: blue PP nonwoven/blue PE-film/white PP nonwoven, blue absorbent patch 25 x 60 cm, PP nonwoven
1 Adhesive drape medium	180 x 180 cm, Laminate: blue PP nonwoven/blue PE-film/white PP nonwoven, blue absorbent patch 25 x 60 cm, PP nonwoven, Tube holders in nonwoven
1 Adhesive drape large	150 x 240 cm, Laminate: blue PP nonwoven/blue PE-film/white PP nonwoven, blue absorbent patch 25 x 60 cm, PP nonwoven, Tube holders
1 Instrument table cover	150 x 190 cm, laminate: PP nonwoven/PE film, blue

## evercare<sup>®</sup> Universal set without Mayo stand cover, 3-layer, 25x60 cm patches

REF: 1015-02

evercare<sup>®</sup> Universal set without Mayo stand cover, sterile. The components in size 180 x 180 cm and 150 x 240 cm are designed with adhesive tape with cut peel-papers in shorter length to ease the draping and allow sequenced covering.

### Key Features

- ▶ Absorbent patch
- ▶ Tube holders
- ▶ Adhesive OP Tape
- ▶ Main drape complies to EN 13795-1 High performance critical product area requirements

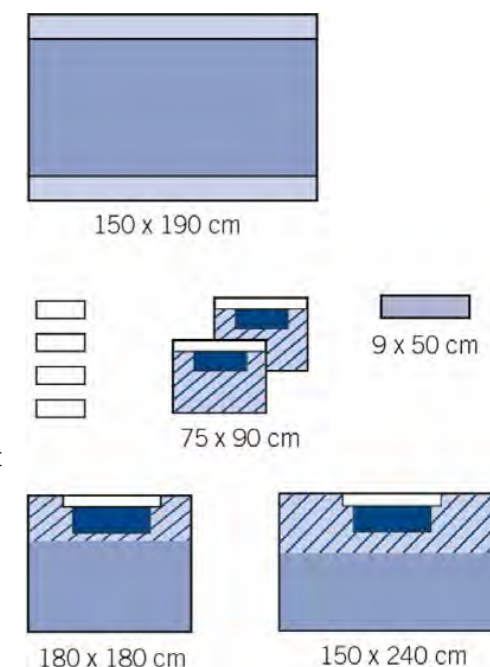

REF	DESCRIPTION	SIZE	Pack Count dispenser/carton
1015-02	Universal set without Mayo stand cover, sterile	See Material table	6 / 12

### Material

Product Part	Raw Material & Characteristics
2 Adhesive drape sheet	75 x 90 cm, Laminate: blue PP nonwoven/blue PE-film/white PP nonwoven, absorbent patch 25 x 60 cm, PP nonwoven
1 Adhesive Op-tape	9 x 50 cm, Nonwoven, blue
4 Hand towel	30 x 34 cm, Pulp, natural white, thread reinforced
1 Adhesive drape, medium	180 x 180 cm Laminate: blue PP nonwoven/blue PE-film/white PP nonwoven, blue absorbent patch 25 x 60 cm, PP nonwoven
1 Adhesive drape, large	150 x 240 cm, Laminate: blue PP nonwoven/blue PE-film/white PP nonwoven, blue absorbent patch 25 x 60 cm, PP nonwoven
1 Instrument table cover	150 x 190 cm, laminate: PP nonwoven/PE film, blue

## evercare<sup>®</sup> Utility drape, 45 x 75 cm

REF: 1408

evercare<sup>®</sup> Utility drape, sterile for creating aseptic working surfaces.



45 x 75 cm

### Key Features

- ▶ Available in several sizes
- ▶ Complies to EN 13795-1 High performance critical product area requirements

REF	DESCRIPTION	SIZE	Pack Count dispenser/carton
1408	Utility drape, sterile, Blue	45 x 75 cm	30 / 120

Sales Unit: Transport Carton

## evercare<sup>®</sup> Utility drape

REF: 1410-01, 1415-01

evercare<sup>®</sup> Utility drape, sterile for creating aseptic working surfaces.

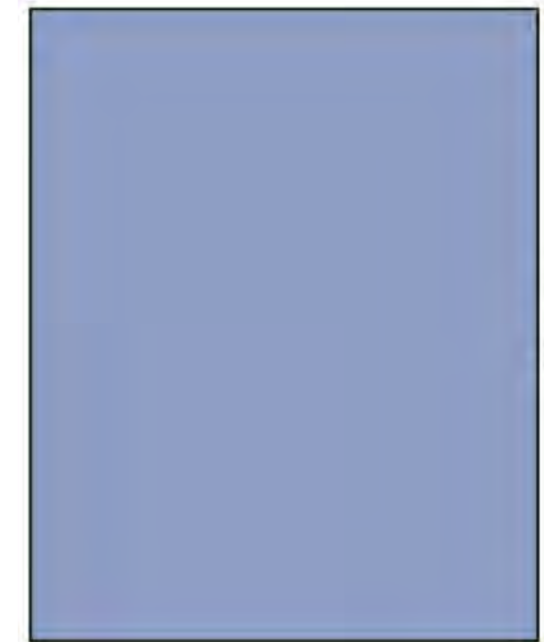

50 cm

60 cm

### Key Features

- ▶ Available in several sizes
- ▶ Complies to EN 13795-1 High performance critical product area requirements

REF	DESCRIPTION	SIZE	Pack Count dispenser/carton
1410-01	Utility drape, sterile, Blue	50 x 60 cm	45 / 180
1415-01	Utility drape, sterile, Blue	75 x 90 cm	25 / 100

Sales Unit: Transport Carton

evercare® Universal cover drape 150 x 240 cm extra reinforced  
REF: 1418

evercare® Universal cover drape, extra reinforced, sterile.



### Key Features

- ▶ Extra reinforced
- ▶ Complies to EN 13795-1 High performance less critical product area requirements

REF	DESCRIPTION	SIZE	Pack Count dispenser/carton
1418	Universal cover drape, extra reinforced, sterile, Dark blue	150 x 240 cm	9 / 36

Sales Unit: Transport Carton

evercare® Universal cover drape  
REF: 1715-01, 1720-01, 1725-01

evercare® Instrument table cover, sterile is a strong and durable universal cover drapes with 75 cm absorption area.

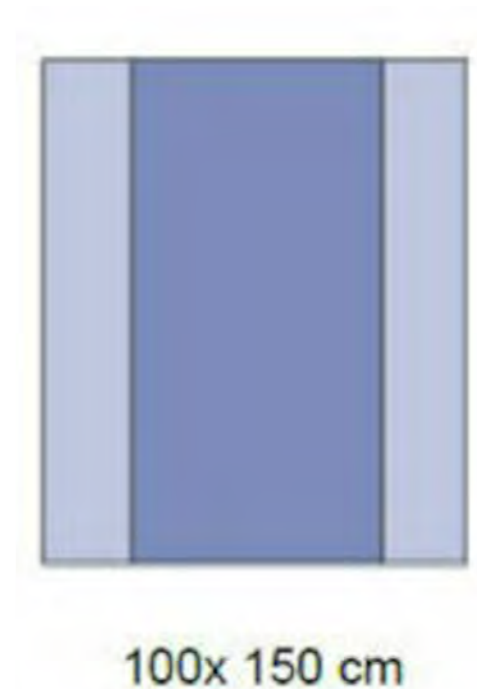

### Key Features

- ▶ Available in several sizes
- ▶ Complies to EN 13795-1 High performance critical product area requirements

REF	DESCRIPTION	SIZE	Pack Count dispenser/carton
1715-01	Instrument table cover, sterile, Blue	100 x 150 cm	18 / 72
1720-01	Instrument table cover, sterile, Blue	140 x 150 cm	16 / 64
1725-01	Instrument table cover, sterile, Blue	150 x 190 cm	15 / 60

Sales Unit: Transport Carton

## evercare<sup>®</sup> Universal cover drape, 150 x 190 cm, reinforced

REF: 1727-01

evercare<sup>®</sup> Instrument table cover, reinforced, sterile is an extra strong and durable universal cover drapes with 75 cm absorption area.

### Key Features

- ▶ Extra strong and durable
- ▶ Complies to EN 13795-1 High performance critical product area requirements



REF	DESCRIPTION	SIZE	Pack Count dispenser/carton
1727-01	Instrument table cover, reinforced, sterile, Blue	150 x 190 cm	10 / 40

Sales Unit: Transport Carton

## evercare<sup>®</sup> Universal cover drape, 150 x 190 cm, transparent

REF: 1728

evercare<sup>®</sup> Universal cover drape, transparent, sterile is a strong and durable universal cover drape.

### Key Features

- ▶ Transparent one layer
- ▶ Complies to EN 13795-1 High performance critical product area requirements

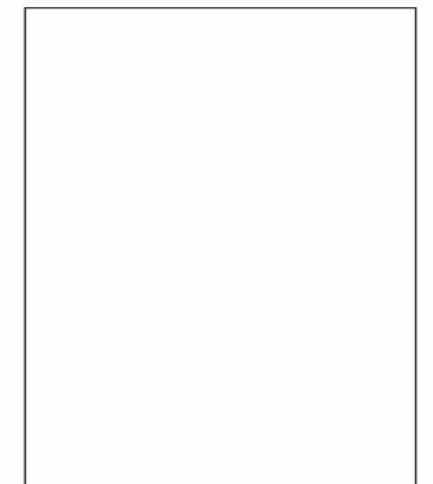

150 x 190 cm

REF	DESCRIPTION	SIZE	Pack Count dispenser/carton
1728	Universal cover drape, sterile, Transparent	150 x 190 cm	20 / 80

Sales Unit: Transport Carton

# evercare® Head/neck drape

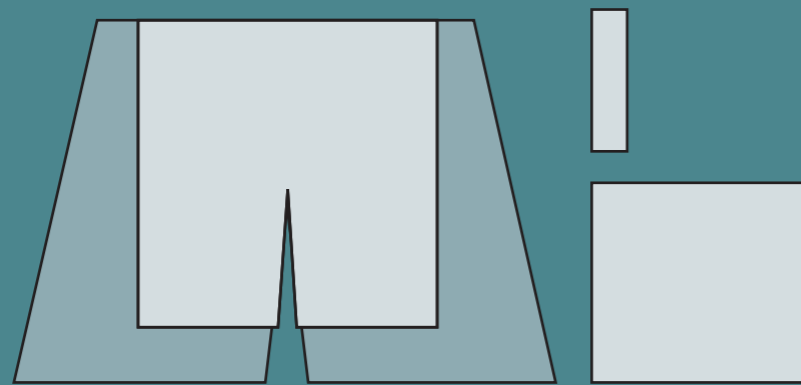

## evercare® Head/neck drape

REF: 1291-02

evercare® Head/neck, sterile is a draping for head/neck surgery.

Product Data Sheet

### Key Features

- ▶ Easy to drape
- ▶ Main drape complies to EN 13795-1 High performance critical product area requirements

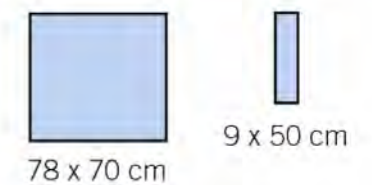
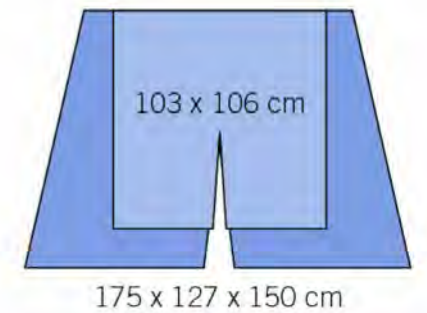

REF	DESCRIPTION	SIZE	Pack Count dispenser/carton
1291-02	Head/neck, sterile	See Material table	10 / 40

Sales Unit: Transport Carton

### Material

Product Part	Raw Material & Characteristics
2 Head/neck drapes	103 x 106 cm, 175 x 127 x 150 cm, Spunlace nonwoven, blue Laminate: blue PP nonwoven/blue PE-film
1 Op-tape	9 x 50 cm, Nonwoven polyester, blue, adhesive coated
1 Table cover	78 x 70 cm, Laminate: blue PP nonwoven/blue PE-film

# evercare<sup>®</sup> medical We care more



[www.evercare-medical.com](http://www.evercare-medical.com)



Follow us on LinkedIn

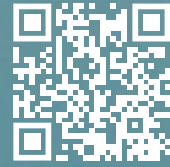

Subscribe on YouTube

**Embra** <sup>®</sup>  
Caring for the future

 **evercare** <sup>®</sup>  
Solutions for premium care

 **SELEFA** <sup>®</sup>  
Affordable solutions for care

Evercare Medical AB is a partner that enables better lives for patients, facilitates everyday life for healthcare employees and contributes to lower care costs. We strive to reduce the environmental impact and, together with our suppliers, to improve working conditions throughout the value chain.